

ACCESSORIES & PARTS

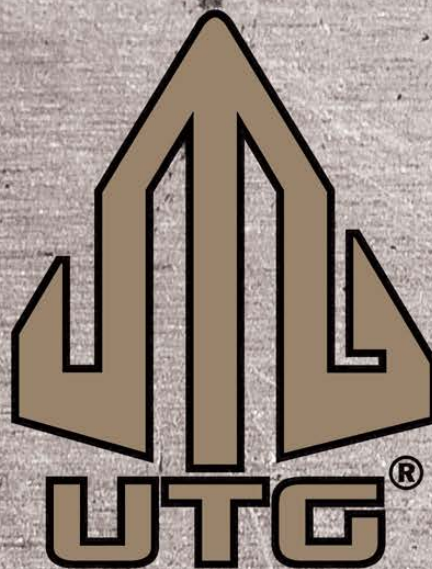

YOUR ONE STOP SHOP



ADVANCED MANUFACTURING • TIGHT TOLERANCES • UNMATCHED QUALITY CONTROL



MODEL 4 COMBAT OPS READY S1 6-POSITION STOCKS AND ASSEMBLIES

PROUDLY MADE IN USA

NEW!



D **FLAT DARK EARTH**

- RBUS1DM**
Mil-spec Stock Assembly
- RBUS1DC**
Commercial-spec Stock Assembly
- RBUS1DMS**
Mil-spec Stock Only
- RBUS1DCS**
Commercial-spec Stock Only



B **BLACK**

- RBUS1BM**
Mil-spec Stock Assembly
- RBUS1BC**
Commercial-spec Stock Assembly
- RBUS1BMS**
Mil-spec Stock Only
- RBUS1BCS**
Commercial-spec Stock Only



- 1** Removable Waterproof Battery Cover Caps
- 2** Dual Storage Compartments Store Up to 8 CR123 Batteries
- 3** Heavy Duty Pattern for Maximum Traction
- 4** Slanted Cheek Rest for Optimal Comfort



- 6** Ambidextrous Standard Sling Loop
- 7** Extended Front End Enables Stock to be Flush with the Lower Receiver for a More Integral Look
- 8** Reversible QD Sling Swivel Housing
- 9** Latch for 6-Position Adjustment



- 5** Ergonomically Chamfered Built-in Rubberized Butt Pad

STOCK ASSEMBLY INCLUDES:



- MADE IN USA** Stock Molded from Impact Resistant High Strength Polymer
- Extended 8" Length for Increased Length of Pull - Combine with Our Super Slim Handguards for a Superior Firearm Handling Experience
- Built for Heavy Duty Use with the Tightest Tolerance Controls to Provide the Most Secure Fit and Function
- **MADE IN USA** 6-Position Extension Tube
 - Precision Machined from 6061/T6 Aircraft Grade Aluminum Alloy
 - Matte Black Type III Hard Coat Anodize or FDE Cerakote

MODEL 4 COMBAT OPS READY S2 6 POSITION STOCKS AND ASSEMBLIES

PROUDLY MADE IN USA



NEW!

D

FLAT DARK
EARTH

RBUS2DM
Mil-spec
Stock Assembly

RBUS2DMS
Mil-spec
Stock Only

RBUS2DC
Commercial-spec
Stock Assembly

RBUS2DCS
Commercial-spec
Stock Only



B

BLACK

RBUS2BM
Mil-spec
Stock Assembly

RBUS2BMS
Mil-spec
Stock Only

RBUS2BC
Commercial-spec
Stock Assembly

RBUS2BCS
Commercial-spec
Stock Only



1 Ergonomically Chamfered Built-in Rubberized Butt Pad with Heavy Duty Pattern for Maximum Traction



2 Slanted Cheek Rest for Optimal Comfort

3 Reversible QD Sling for Optimal Comfort

4 Ambidextrous Standard Sling Loop



5 Extended Front End Enables Stock to be Flush with the Lower Receiver for a More Integral Look

6 Latch For 6-Position Adjustment



STOCK ASSEMBLY INCLUDES:

- MADE IN USA** Stock Moulded from Impact Resistant High Strength Polymer
- Extended 7.5" Length for Increased Length of Pull - Combine with Our Super Slim Handguards for a Superior Firearm Handling Experience
- Built for Heavy Duty Use with the Tightest Tolerance Controls to Provide the Most Secure Fit and Function
- MADE IN USA** 6-Position Extension Tube
 - Precision Machined from 6061/T6 Aircraft Grade Aluminum Alloy
 - Matte Black Type III Hard Coat Anodize or FDE Cerakote



FDE

6-Position
Extension Tube
Commercial (TLU006D)
Mil-spec (TLU001D)



Recoil
Buffer



6-Position
Extension Tube
Commercial (TLU006)
Mil-spec (TLU001)



Receiver End Plate

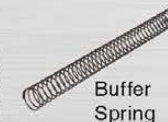

Buffer
Spring



Castle Nut



MODEL 4 COMBAT OPS READY S3 6-POSITION STOCKS AND ASSEMBLIES

PROUDLY MADE IN USA

NEW!



D FLAT DARK EARTH

RBUS3DM
Mil-spec
Stock Assembly

RBUS3DMS
Mil-spec
Stock Only

RBUS3DC
Commercial-spec
Stock Assembly

RBUS3DCS
Commercial-spec
Stock Only



B BLACK

RBUS3BM
Mil-spec
Stock Assembly

RBUS3BMS
Mil-spec
Stock Only

RBUS3BC
Commercial-spec
Stock Assembly

RBUS3BCS
Commercial-spec
Stock Only



1 Heavy Duty Pattern for Maximum Traction **2** Slanted Cheek Rest for Optimal Comfort



3 Reversible QD Sling Swivel Housing **4** Ambidextrous Standard Sling Loop **5** Unique 6.05" Length and Sub Compact Profile



6 Latch for 6 Position Adjustment

STOCK ASSEMBLY INCLUDES:



FDE 6-Position Extension Tube Commercial (TLU006D) Mil-spec (TLU001D)

6-Position Extension Tube Commercial (TLU006) Mil-spec (TLU001)

Buffer Spring

Recoil Buffer

Receiver End Plate

Castle Nut

- **MADE IN USA** Stock Molded from Impact Resistant High Strength Polymer
- Unique 6.05" Length and Sub Compact Profile for Superior Lightweight, yet Comfortable Performance with 6-Position Adjustability - Combine with Our Super Slim Handguards for a Superior Firearm Handling Experience
- Built for Heavy Duty Use with the Tightest Tolerance Controls to Provide the Most Secure Fit and Function
- **MADE IN USA** 6-Position Extension Tube
 - Precision Machined from 6061/T6 Aircraft Grade Aluminum Alloy
 - Matte Black Type III Hard Coat Anodize or FDE Cerakote

UTG PRO **MODEL 4 6-POSITION STOCK ASSEMBLIES**
PROUDLY MADE IN USA

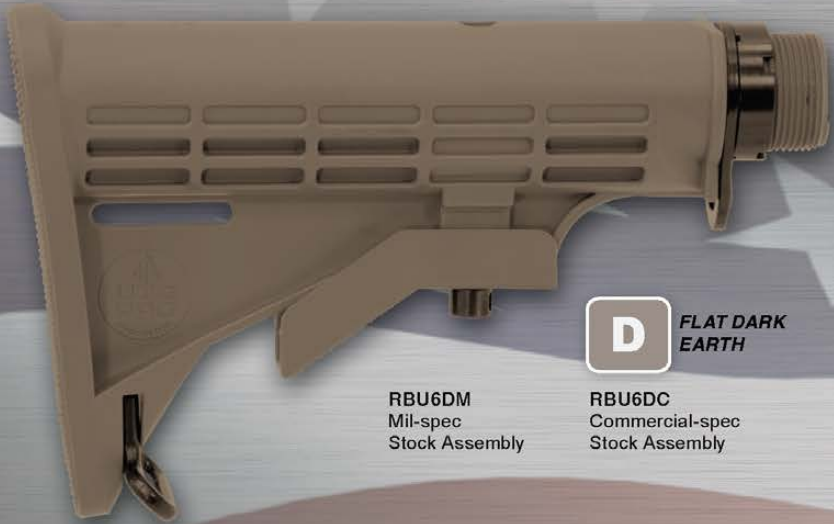

RBU6DM
Mil-spec
Stock Assembly

D **FLAT DARK EARTH**

RBU6DC
Commercial-spec
Stock Assembly

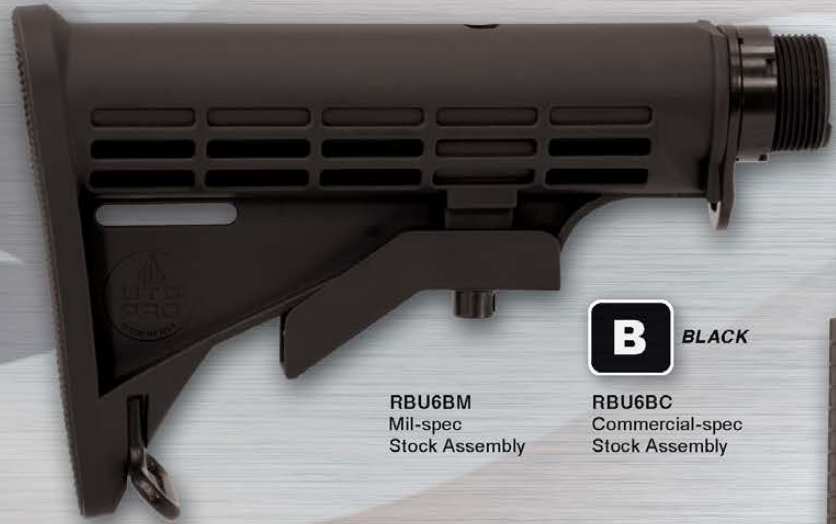

RBU6BM
Mil-spec
Stock Assembly

B **BLACK**

RBU6BC
Commercial-spec
Stock Assembly



Tight Tolerance Controls to Provide the Most Secure Fit and Function



Impact Resistant Polymer with Reinforced Stress Points for Maximum Durability



Official UTG PRO Logo Boasts Superb Quality



STOCK ASSEMBLY INCLUDES:

- **MADE IN USA** Polymer Stock Molded from Impact Resistant High Strength Material
- Built for Heavy Duty Use with the Tightest Tolerance Controls to Provide the Most Secure Fit and Function
- **MADE IN USA** 6-Position Extension Tube
 - Precision Machined from 6061/T6 Aircraft Grade Aluminum Alloy
 - Matte Black Type III Hard Coat Anodize or FDE Cerakote

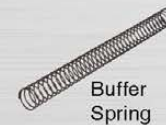



MODEL 4 & 308 STOCK ASSEMBLIES

MODEL 4 LE COMMERCIAL-SPEC 4-POSITION STOCK ASSEMBLY

B RB-T4BC
BLACK

- MADE IN Commercial-spec 4-Position Extension Tube
 - Precision Machined from 6061/T6 Aircraft Grade Aluminum Alloy
 - Matte Black Type III Hard Coat Anodize
- Molded from Impact Resistant High Strength Polymer
- Built for Heavy Duty Use with the Tightest Tolerance Controls to Provide the Most Secure Fit and Function

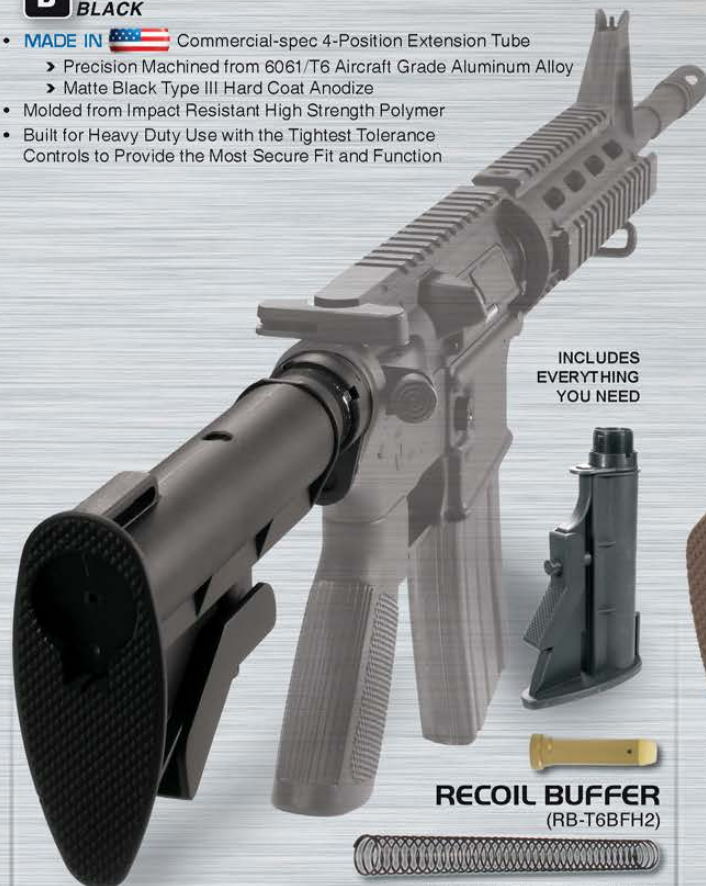

INCLUDES
EVERYTHING
YOU NEED

RECOIL BUFFER
(RB-T6BFH2)



BUFFER SPRING



COMMERCIAL-SPEC
4-POSITION
EXTENSION TUBE
(TLU004)



4-POSITIONS

CASTLE NUT



TEAR DROP RING



NEW GEN MODEL 4 STANDARD A2 FIXED BUTT STOCK ASSEMBLY

D RB-T469D
FLAT DARK EARTH **B** RB-T469B
BLACK

- Molded from Impact Resistant High Strength Polymer
- Storage Compartment for Cleaning Kit, Small Parts, and Other Accessories



INCLUDES
EVERYTHING
YOU NEED

RECOIL BUFFER
(RB-T469BFHC)



BUFFER SPRING



RIFLE LENGTH EXTENSION TUBE



STOCK SPACER



SCREW



MODEL 308 STANDARD A2 FIXED BUTT STOCK ASSEMBLY

B RB-T308FB
BLACK

- Molded from Impact Resistant High Strength Polymer
- Storage Compartment for Cleaning Kit, Small Parts, and Other Accessories



INCLUDES
EVERYTHING
YOU NEED

RECOIL BUFFER
(RB-T469B8BFHC)



BUFFER SPRING



RIFLE LENGTH EXTENSION TUBE



STOCK SPACER



SCREW





MODEL 4 LE TACTICAL COMPACT A2 FIXED STOCK ASSEMBLY

B MODEL 4 COMPACT A2 FIXED BUTT STOCK ASSEMBLY

RB-T469SB
BLACK

- Ideal for Use with Body Armor
- Molded from Impact Resistant High Strength Polymer
- Optimized Length of Pull (LOP) for Use with Load Bearing Vests and Body Armor



INCLUDES
EVERYTHING
YOU NEED

RECOIL BUFFER



BUFFER SPRING



COMPACT EXTENSION TUBE



SCREW

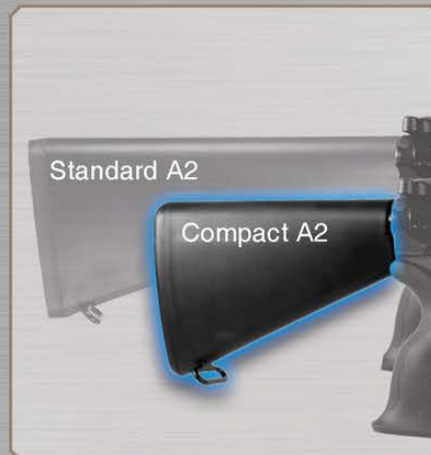



MODEL 4 RECEIVER EXTENSION TUBES

PROUDLY MADE IN USA



Precision Rolled Threads Precisely and Easily Screws into Lower Receivers and Adaptors



Tightest Tolerance Control for Secure Fit and Function with Collapsible Stocks



Matte Black Type III Hard Coat Anodize or FDE Cerakote

COMMERCIAL SPEC 4-POSITION EXTENSION TUBE

B TLU004
BLACK

MATTE BLACK TYPE III
HARD COAT ANODIZE

COMMERCIAL SPEC 6-POSITION EXTENSION TUBE

B TLU006
BLACK

PRECISION MACHINED FROM 6061/T6
AIRCRAFT GRADE ALUMINUM

MIL SPEC 6-POSITION EXTENSION TUBE

B TLU001 BLACK **D** TLU001D FLAT DARK EARTH

TIGHTEST TOLERANCE CONTROLS TO PROVIDE THE MOST
SECURE FIT AND FUNCTION WITH COLLAPSIBLE STOCKS



.308 6-POSITION EXTENSION TUBE

B TLU002
BLACK

100% PROUDLY MADE IN USA

PRECISION CNC MACHINING

MADE FROM 6061/T6 AIRCRAFT GRADE ALUMINUM

TIGHTEST TOLERANCE CONTROLS





QUICK RELEASE BIPOD GRIP

MNT-DG01Q

RAPID TRANSITION FROM CQB TO LONG RANGE SHOOTING



Picatinny Mount Base with Steel Cross Bolt



Integral Quick Detachable Lever Lock for Picatinny/Weaver Rails
U.S. Patent: 8397421



Quick Release Button Instantly Deploys Bipod Legs on Demand



SPECIFICATIONS
GRIP HEIGHT: 5.1"
BIPOD HEIGHT: 8.0"

US PATENT 8397421
EU REG 002245522-0001
EU REG 002245522-0002
PENDING:
US PATENT D727455
US PATENT 9,169,958

D EMPLOYS WITH EASE
D DEFIES THE NORM
D DESIGNED IN DETROIT



Ergonomically Contoured Grip



Heavy Duty Full Metal Construction with Hard Coat Anodize



Non-slip Rubber Grip Panels



Textured Anti-slip Foot Base



APACHE GRIP

2-IN-1 HAND STOP AND FOREGRIP



US PATENT D726278

B

RB-FGRP180B
BLACK

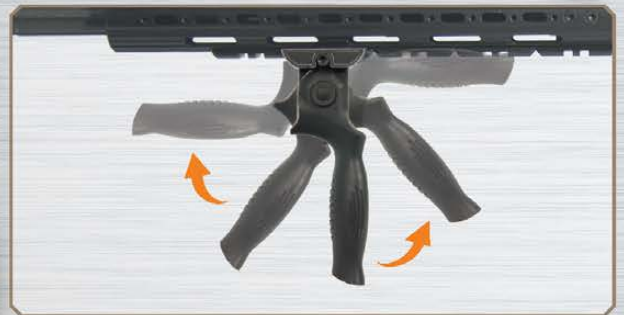

Bi-directional 5-position Folding



Flush with Rail Providing Lowest Possible Profile

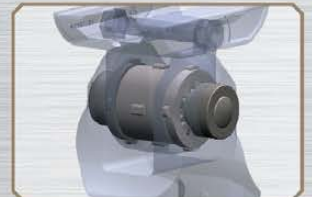

Heavy Duty Full Metal Locking and Folding Mechanism



Reversible Installation for Hand Stop Function



Ergonomic Design for Optimal Comfort



UNIVERSAL AMBIDEXTROUS FOREGRIPS



B

RB-FGRP268B
BLACK



D

RB-FGRP168D
FLAT DARK
EARTH

G

RB-FGRP168G
OD GREEN

B

RB-FGRP168B
BLACK



Ergonomic Finger Grooves and
Nonslip Grip Texture



Rounded Ambidextrous
Contour



Left and Right Pressure Switch
Housings Concealed by
Removable Flush Fitting
Side Inserts



Installation End Cap
with Concealed
Battery Storage Compartment



Slide On Picatinny
Mounting Deck



Simply Screw in End Cap to
Lock the Locking Nub
into a Picatinny Slot to
Complete Installation



2 AA Batteries
or 3 Lithium
Batteries

Concealed Battery
Compartment



UNIVERSAL AMBIDEXTROUS FOREGRIP

5-POSITION FOLDABLE FOREGRIP



D

RB-FGRP170D
FLAT DARK
EARTH

G

RB-FGRP170G
OD GREEN

B

RB-FGRP170B
BLACK



ERGONOMICALLY CONTOURED FOREGRIP



RB-TPG172D
(Also Refer to P. 137)

D

RB-FGRP172D
FLAT DARK
EARTH

B

RB-FGRP172B
BLACK

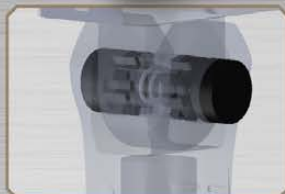

Heavy Duty Full Metal Locking and Folding Mechanism



Installation End Cap with Concealed Battery Storage Compartment



Left and Right Pressure Switch Housings Concealed by Removable Flush Fitting Side Inserts



Nonslip Textured Finger Grooves and Back Strap



Built in Storage Compartment with Removable End Cap



Ergonomic Symmetrical Design Reduces Wrist Fatigue and Improves Handling



UNIVERSAL ALUMINUM QD FOREGRIPS

STRENGTH & INNOVATION

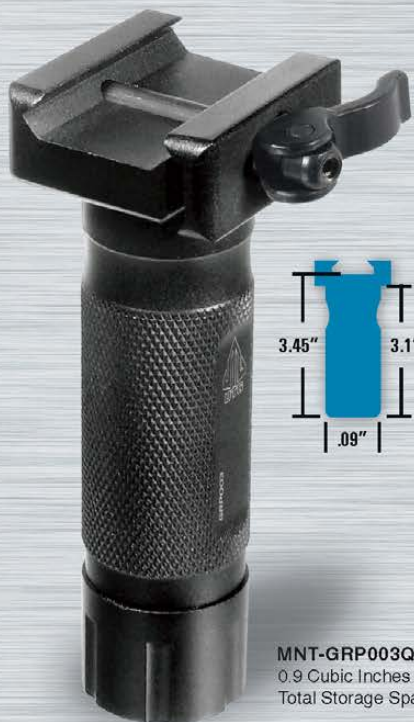

MNT-GRP003Q
0.9 Cubic Inches
Total Storage Space



MNT-GRP001SQ
1.46 Cubic Inches
Total Storage Space



MNT-GRP001Q
2.7 Cubic Inches
Total Storage Space



MNT-GRP002SQ
1.04 Cubic Inches
Total Storage Space



Knurled Surface Texture for Added a Secure Grip



Durable Aluminum Alloy Construction with Matte Black Type III Hard Coat Anodize



Battery Storage Compartment with Waterproof End Cap



Integral Quick Detachable Lever Lock for Picatinny/Weaver Rails



Picatinny Mount Base with Steel Cross Bolt



Folding Operation
U.S. Patent: 8,397,421 8,429,843



MODEL 4 PISTOL GRIPS



AMBIDEXTROUS

NEW!

B

RBUPG01B
BLACK

D

RBUPG01D
FLAT DARK EARTH



MODEL 4 COMBAT SNIPER PISTOL GRIP



RIGHT HAND



B

RB-TPG269B
BLACK

D

RB-TPG269D
FLAT DARK EARTH

G

RB-TPG269G
OD GREEN



AMBIDEXTROUS



B

RB-TPG172B
BLACK

D

RB-TPG172D
FLAT DARK EARTH



Fully Ambidextrous Design for Left and or Right Hand Shooters



Ergonomic Palm Swells Reduce Fatigue and Improves Handling



Heavy Duty Polymer Construction with Rubberized Over Mold



Nonslip Textured Over Mold



Ergonomic Trigger Finger Shelf Aids in Consistent Placement of Trigger Finger When Firing



Built in Storage Compartment with Removable End Cap



Built in Storage Compartment with Removable End Cap



Compatible with Ambidextrous Safeties



Built in Storage Compartment with Removable End Cap



Ergonomic Trigger Finger Swell Aids in Consistent Placement of Trigger Finger When Firing



Ergonomic Symmetrical Design Reduces Wrist Fatigue and Improves Handling



Nonslip Textured Finger Grooves and Back Strap



MODEL 4 FRONT SIGHTS

LOW PROFILE SIGHTS FOR SAME PLANE APPLICATIONS



UTG Model 4 Low Profile Flip-up Front Sight

MNT-755

- Aluminum/steel Construction with Matte Black Hard Coat Anodize
- Standard A2 Front Sight Post with Precise Elevation Adjustment
- Posi-lock Plunger Coupled with Spring Activated Ball Bearing Guarantees Zero Retention
- Low Profile 3mm Locking Bolt and Mounting Deck Securely Attaches to Any Picatinny Rail
- Designed to Match MNT-955 Low Profile Flip-up Rear Sight on Same Level Plane Applications
- Low Profile Locking Bolt
[Also Refer to P. 64]



UTG Low Profile Flip-up Front Sight

MNT-751L

- Aluminum/steel Construction with Matte Black Hard Coat Anodize
- Quick Detach Front Sight with Adjustable A2 Square Post Assembly, Fits All Picatinny/weaver Rails
- Equipped with Locking Thumb Nut, Spring Activated Ball Bearing, and Recessed Sight Base
- Standard A2 Front Sight Post with Precise Elevation Adjustment
[Also Refer to P. 62]



UTG Low Profile Front Sight

MNT-754

- Aluminum/steel Construction with Matte Black Hard Coat Anodize
- Quick Detach Front Sight with Adjustable A2 Square Post Assembly, Fits All Picatinny/weaver Rails
- Standard A2 Front Sight Post with Precise Elevation Adjustment
[Also Refer to P. 62]



UTG High profile Front Sight

MNT-750

- Aluminum/steel Construction with Matte Black Hard Coat Anodize
- Quick Detach Front Sight with Adjustable A2 Square Post Assembly, Fits All Picatinny/weaver Rails
- Standard A2 Front Sight Post with Precise Elevation Adjustment
[Also Refer to P. 62]



UTG High Profile Flip-up Front Sight

MNT-751

- Aluminum/steel Construction with Matte Black Hard Coat Anodize
- Quick Detach Front Sight with Adjustable A2 Square Post Assembly, Fits All Picatinny/weaver Rails
- Standard A2 Front Sight Post with Precise Elevation Adjustment
[Also Refer to P. 62]

12 GA. SHOTGUN/.22 FRONT SIGHT



FOR MOSSBERG 12 GA. & VARIANTS



MNT-722

- Clamp-on Front Sight with Elevation Adjustable Front Sight Post
- Fits Mossberg 12 Ga. Shotgun and Variants Equipped with Front Sight Bead
- Designed to Match MNT-910 Low Profile Rear Sight
- Complete with 2 in 1 Sight Adjustment Tool
[Also Refer to P. 65]

FOR RUGER 10/22 & MOSSBERG 702



MNT-716

- Clamp-on Front Sight with Elevation Adjustable Front Sight Post
- Designed to Match MNT-910 Low Profile Rear Sight
- Complete with 2 in 1 Sight Adjustment Tool
[Also Refer to P. 65]



MODEL 4 FRONT SIGHT TOOLS

4-PRONG A2 FRONT SIGHT TOOL



SCP-FTA24

- One Piece Machined Steel with Knurled Surface Texture for Added Gripping Performance
- For Use on 4-prong A2 Front Sight Posts

DUAL FRONT SIGHT TOOL



SCP-A1245-A

- One Piece Machined Steel with Knurled Surface Texture for Added Gripping Performance
- For Use on Both 4 and 5-prong Front Sight posts



MODEL 4/SHOTGUN/.22 REAR SIGHTS



UTG Model 4 Low Profile Flip-up rear Sight

MNT-955

- Aluminum/steel Construction with Matte Black Hard Coat Anodize
- Super Compact Profile and Exact Height to Work with Standard Front Sight
- Posi-lock Plunger Coupled with Spring Activated Ball Bearing Guarantees Zero Retention
- Choose Between a Large or Small Size Aperture for Moving Target Engagements, Limited Visibility, or Normal Firing Situations
- Optimal Height for Co-witnessing with Dot Sights
- Low Profile 3mm Locking Bolt and Mounting Deck Securely Attaches to Any Picatinny Rail
- Designed to Match MNT-755 Low Profile Flip-up Front Sight on Same Level Plane Applications [Also Refer to P. 64]

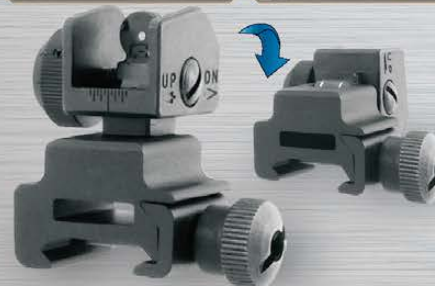

UTG Flip-up Rear Sight

MNT-951

- Aluminum/steel Construction with Matte Black Hard Coat Anodize
- Flip-up Tactical Rear Sight with Windage Adjustment and Integral Picatinny Mounting Deck
- Equipped with Integral Picatinny QD Twist Lock Thumb Nut, Spring Activated Ball Bearing, and Recessed Sight Base [Also Refer to P. 63]

UTG Mil-spec Compact A2 Rear Sight

MNT-950CS

- Mil-spec Compliant Compact A2 Rear Sight with Full Range Windage/elevation Adjustment and Integral Picatinny QD Twist Lock Thumb Nut [Also Refer to P. 63]

UTG Match-grade Rear Sight

MNT-950RS02-B

- Aluminum/steel Construction with Matte Black Hard Coat Anodize
- Equipped with a Large or Small Size Aperture for Moving Target Engagements, Limited Visibility, or Normal Firing Situations [Also Refer to P. 63]



UTG Sub-compact Shotgun/.22 Aperture Adjustable Rear Sight

MNT-910

- Precision Machined Aircraft Grade Aluminum Construction with Matte Black Hard Coat Anodize
- Designed to Match MNT-722 & 716 Clamp-on Front Sights
- Optimally Sized Aperture for Accurate Aiming
- Complete Windage/Elevation Adjustment in an Extremely Sub Compact Design
- Sub Compact Profile and Super Lightweight
- One Piece Integral Mounting Base Fits Any Picatinny and Most Weaver Rails [Also Refer to P. 65]



UTG PRO Made in USA Model 4 Mil-spec 7075-T6 Forged Carry Handle Sight

TLURS001

- Mil-spec Match Grade Carry Handle with A2 Sight Assembly
- Features Forged 7075-T6 Aluminum Alloy Base with Matte Black Type III Hard Coat Anodize Rugged Steel A2 Sight Assembly Provides Precision and Reliable Windage/elevation Adjustment, Complete with Dual Aiming Apertures
- Optimal Height for Co-witnessing with Standard Front Sight and Similarly Raised Electronic Dot Sights
- Equipped with Locking Thumb Nut for Easy and Secure Installation [Also Refer to P. 63]





MODEL 4 APPLICATION

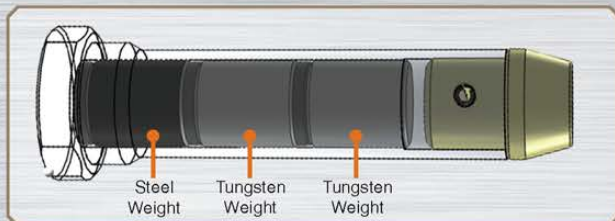

MODEL 4 CARBINE H2 RECOIL BUFFER

RB-T6BFH2

- Complete with 2 Heavy Tungsten Weights and 1 Steel Weight
- Reinforced Buffer Body with Hardcoat Anodize
- Total Weight: 4.6oz



MODEL 4 STANDARD FULL SIZE RECOIL BUFFER

RB-T469BFHC

- Complete with 5 Steel Weights for Smooth Rifle Cycling and Better Reliability
- Reinforced Buffer Body with Hardcoat Anodize
- Total Weight: 5.0oz



MODEL 308 STANDARD FULL SIZE RECOIL BUFFER

RB-T469B8BFHC

- Complete with 6 Steel Weights for Smooth Rifle Cycling and Better Reliability
- Reinforced Buffer Body with Hardcoat Anodize
- Total Weight: 5.3oz

B RB-M4BTP01B-A

B RB-M4BTP11B

G RB-M4BTP11G

MODEL 4 ERGONOMIC BUTT PAD FOR 6-POSITION RETRACTABLE STOCK

- Adds Over a 1" Extension to Model 4 Collapsible Stocks
- Provides Additional Comfort When Shouldered



UTG EXTENDED CHARGING HANDLE LATCH

TL-CHL01

- Increased Surface Area for Faster Manipulation Under Stress
- Heavy Duty Steel Construction with Matte Black Hardcoat Anodize
- Fits Standard AR15 Charging Handles



MODEL 4 RECEIVER WEDGE

RB-A005

- Snugly Fits Behind Rear Take Down Pin
- Keeps the Upper Snug and Tight Against the Lower
- Prevents Upper and Lower Receivers from Rattling
- Improves Accuracy, Reduces Excess Vibrations, and Prevents Excessive Wear



MODEL 15 DUAL MAGAZINE CLAMP

TL-A050

Compatible with 20 and 30 Round Standard GI Magazines



MODEL 4 HEAVY DUTY BLANK FIRING ADAPTOR



Carbine
MNT-16AD2-C



Rifle
MNT-16AD1-C

- 3rd Gen Blank Firing Adaptor for Carbine Length and Rifle Length AR15
- Fits Standard A2 Flash Hider and Barrel
- Precision Machined High Strength Steel Alloy Construction
- User Friendly Bolt Ring for Simple Installation and Removal
- Color Coated for Protection and Discernibility
- Reinforced Integral Housing and Reliable Mil-spec Quality
- Ideal for Law Enforcement and Military Training



One Piece Heavy Duty Cast Hex Nut and Frame for Maximum Durability
(Surpassing Military Standards)



Precision Machined Reinforced Frame



Thousands of Rounds of Testing to Ensure Mil-standard Performance



MODEL 4 & 308 WRENCHES

UTG MINI AR15 WRENCH TOOL

TL-ARWR02

- Designed for both AR15 Installation and Removal of Barrel Nut, Muzzle Brake, and Extension Tube
- Heavy Duty Steel Alloy Construction with Matte Black Type III Hard Coat Anodize



UTG MODEL AR15/AR 308 ARMORER'S COMBO WRENCH TOOL

TL-ARWR01

- Designed for both AR15 and AR 308 Installation and Removal of Barrel Nut, Muzzle Brake, and Extension Tube
- Heavy Duty Steel Alloy Construction with Matte Black Type III Hard Coat Anodize



1. Flat Head Screw Driver

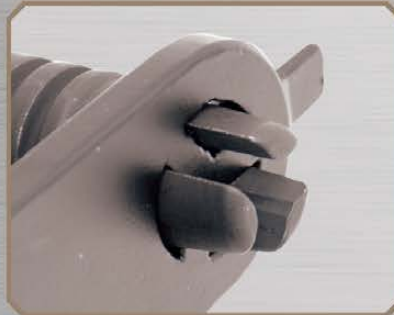

2. Traditional 3-prong Muzzle Wrench



3. Castle Nut Wrench



4. AR10 Muzzle Brake Wrench



5. A2 Stock Extension Tube



6. AR15 Muzzle Brake



7. YHM® and Compatible Barrel Nut Wrench



8. UTG PRO Super Slim Barrel Nut Wrench



9. 1/2" and 1/4" Socket Adaptors



10. Delta Ring Barrel Nut Wrench



MODEL 4 APPLICATIONS



NEW!

KEYMOD COMPATIBLE HANDGUARD COVERS

RB-HP25B

- Polymer Material Withstands Extreme Temperatures (-10° ~170°)
- Tool Free Installation
- Diamond Texture Offers Maximum Comfort and Performance
- Bidirectional Installation



NEW!

KEYMOD COMPATIBLE ALUMINUM HAND STOP

TL-HS02B

- Compatible with UTG PRO Super Slim AR15/ AK Keymod Compatible Handguards
- Promotes Proper Support Hand Memory Placement and Retention
- Ergonomic Contour Improves Firearm Handling and Speeds Up Transitions
- Can be Used to Stop Support Hand from Potentially Muzzling the Front of the Barrel on Short Barrel Rifles and Shotguns



PICATINNY HAND STOP KIT

RB-HS01B
BLACK

- Promotes Proper Support Hand Placement and Retention
- Ergonomic Contour Improves Firearm Handling and Speeds Up Transitions, While Preventing Damage to the Rail

RB-HS01D
FLAT DARK EARTH

- Can be Used to Stop Support Hand from Potentially Muzzling the Front of the Barrel on Short Barrel Rifles and Shotguns
- Also Includes One Low Profile Rubber Rail Guard

RB-HS01G
OD GREEN



LOW PROFILE PICATINNY RUBBER RAIL GUARD

- Low Profile with Curved Contour Hugs Picatinny Rail and Provides a More Comfortable Gripping Surface
- Easily Snaps onto Picatinny Rails Without Shifting due to Integral Stop Bar

RB-HP12B-B
BLACK

RB-HP12D-B
FLAT DARK EARTH

RB-HP12G-B
OD GREEN

- Non-slip Textured Surface for a Positive Support Hand Grip
- Protects the User from Sharp Rail Edges While Preventing Damages to the Rail Itself
- 12 Pieces to a Pack



DUAL HEAT SHIELDS

MODEL 4 DESERT TAN POLYMER HANDGUARD

RB-TM4HGT

- Quality Replacement Handguard for M4 Carbine
- Rounded Shape with Dual Aluminum Heat Shields
- Lightweight and Extremely Tough for Use Under All Weather and Environmental Conditions



AK RECEIVER ADAPTOR AND STOCK KITS



922R COMPLIANT

PROUDLY MADE IN USA



ADJUSTABLE STOCK ADAPTOR



ADJUSTABLE STOCK HEIGHT UP TO 20MM



MADE IN
 THE U.S.A.



MADE IN
 THE U.S.A.



MADE IN
 THE U.S.A.

UTG PRO **MADE IN** **922R COMPLIANT**
AK COLLAPSIBLE STOCK KIT
WITH **GEN I** ERGONOMIC STOCK HEIGHT ADAPTOR
RBU47KT01

- AK Collapsible Stock Kit Includes:
 - Mil-spec 6-position Stock
 - Mil-spec 6-position Extension Tube (TLU001) with Ergonomic AK Stamped Receiver Adaptor (TL-A68747-AD1)

UTG PRO **MADE IN** **NEW GEN 922R COMPLIANT**
AK COLLAPSIBLE STOCK KIT
WITH **GEN II** ELEVATED STOCK HEIGHT ADAPTOR
RBU47KT02

- AK Collapsible Stock Kit Includes:
 - Mil-spec 6-position Stock
 - Mil-spec 6-position Extension Tube with New Gen AK Stamped Receiver Adaptor

UTG PRO **MADE IN** **NEW GEN 922R COMPLIANT**
AK COLLAPSIBLE STOCK KIT
WITH **GEN III** **ADJUSTABLE** STOCK HEIGHT ADAPTOR
RBU47KT03

- AK Collapsible Stock Kit Includes:
 - Mil-spec 6-position Stock
 - Mil-spec 6-position Extension Tube with New Gen AK Stamped Adjustable Receiver Adaptor

★ 6 Position Collapsible Stock

★ User Friendly Installation

★ No Permanent Modifications Required



AK APPLICATION



NEW!

UTG KEYMOD COMPATIBLE HAND STOP

TL-HS02B

- Compatible with UTG PRO Super Slim AR15/AK Keymod Compatible Handguards
- Promotes Proper Support Hand Memory Placement and Retention
- Ergonomic Contour Improves Firearm Handling and Speeds Up Transitions
- Can be Used to Stop Support Hand from Potentially Muzzling the Front of the Barrel on Short Barrel Rifles and Shotguns



GEN I MODEL 4 STOCK ADAPTOR FOR AK STAMPED RECEIVER

TL-A68747-AD1

- Allows Installation and Use of Model 4 Fixed and Collapsible Stocks and Extension Tubes
- Snag-free Design and Optimized for a Naturally Comfortable Sight Alignment When Shouldered



AK SIDE FOLDING STOCK ADAPTOR

TL-K7FAD01

- Requires UTG AK Stock (RBU47KT01) Adaptor for Conversion and Compatible with Most 4-position/6-position Model 4 Stocks and Extension Tubes
- Heavy Duty Aluminum Construction with Matte Black Type III Hard Coat Anodize
- User Friendly Installation
- Increased Mobility and Versatility



AK COMBAT STEEL SIDE PLATE

TL-M47SR

- Precision Machined Dovetail for Installing Side Optic Mounts
- Reinforced Surface Treatment for Greater Wear and Corrosion Resistance
- Fits Both Milled and Stamped Receivers, Accepts a Wide Variety of Side Optic Mounts
- Permanent Modification Required, Installation by Gunsmith Recommended



AK DUAL MAGAZINE CLAMP

TL-MGK702

Fits Classic 7.62X39mm Magazines, Matte Black Finish



AK COMBAT STYLE BUTT PAD

RB-K7BTP01

- Ergonomic Slip-on Design with Reinforced Outer Lip
- 1" Extension, Reduces Felt Recoil, Available in Black Only



B

RB-PGRP478B
BLACK



G

RB-PGRP478G
OD GREEN

ERGONOMIC AK PISTOL GRIP

- Heavy Duty Polymer Construction with Rubberized Over Mold
- Built-in Storage Compartment with Removable End Cap
- Non-slip Textured Over Mold
- Ergonomic Trigger Finger Swell Aids in Consistent Placement of Trigger Finger When Firing



AK SPEED LOADER

TL-K060

- Speed Loads Using 7.62X39mm Stripper Clips



ELEVATION ADJUSTMENT

WINDAGE ADJUSTMENT



AK FRONT SIGHT TOOL

SCP-WEA05

- An Essential Tool for Making Fine Front Sight Post Windage and Elevation Adjustments
- Compatible with AK, SKS, MAK, and SLR95 Pattern Rifles



SKS & OTHER ACCESSORIES



DELUXE COMBAT STYLE 2" SKS BUTT PAD

RB-SKBTP02A

- Ergonomic Slip-on Design with Reinforced Outer Lip
- 2" Extension, Reduces Felt Recoil, Available in Black Only



DELUXE COMBAT STYLE 1" SKS BUTT PAD

RB-SKBTP01A

- Ergonomic Slip-on Design with Reinforced Outer Lip
- 1" Extension, Reduces Felt Recoil, Available in Black Only



SKS SHELL DEFLECTOR

TL-SDSK01

- Deflects Ejecting Spent Cartridges in a Safe Direction and Away from Optics that May be Mounted onto the Receiver
- Made from Spring Steel with Matte Black Type III Hard Coat Anodize
- Installation Screw Holes Compatible with UTG SKS Tri-rail Mount, Hi Profile Mount and Other Similar SKS Mounts

CHAMBER SAFETY FLAG

RB-CSF01

- Bright Orange for High Visibility and Reliable Confirmation of an Unloaded Firearm
- Molded from Impact Resistant Polymer with Reinforced Head for Maximum Durability
- Ideal for Cold Range Use and Mass Produced Firearms



AIRGUN TARGET



TL-TG001

- Removable Rear Metal Wall
- Multi-layer Pellet Resistant Curtains
- 2 Sets of Paper Targets Included
- Reinforced Impact Resistant Polymer Frame
- Recommended Shooting Distance: 30-60 feet
- Tough and User Friendly Design
- 8"x9.75"x9.75"

CALIFORNIA DOJ APPROVED FIREARM CABLE LOCK

TL-GLK01

- Certified by California Department of Justice
- Universal Design Compatible with Most Long Guns and Pistols
- Heavy Duty Hardened Steel Alloy Construction for Maximum Strength and Security
- Ultra Strong Locking Cable 0.21"(5.3mm) in Diameter 15"(381mm) in Length
- Plastic Wrap Prevents Cable from Scratching Firearm Finishes
- Highly Reliable Padlock
- Easy Installation



Autoloading Rifles

Shotguns

Revolvers

Pistols

Bolt Action Rifles



Certified by California Department of Justice





BROKEN SHELL EXTRACTORS | OTHER ACCESSORIES

HOW IT WORKS...

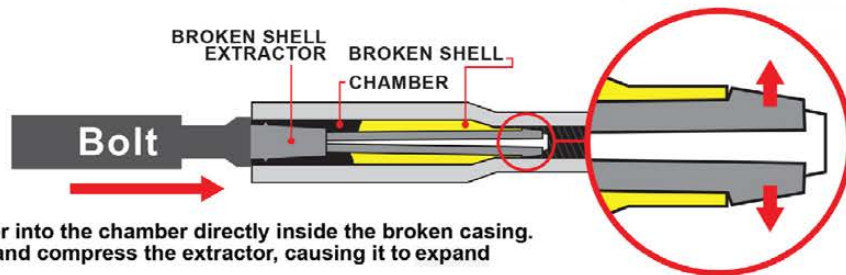

1. Insert the shell extractor into the chamber directly inside the broken casing. Allow the bolt to close and compress the extractor, causing it to expand and grab the casing.

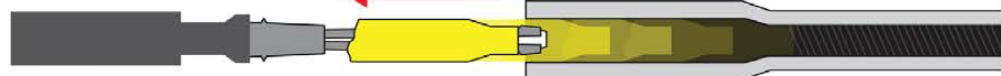

2. Draw back the bolt to eject the broken casing along with the broken shell extractor.

.308 BROKEN SHELL EXTRACTOR

TL-EX308



.223 SHELL EXTRACTOR

TL-EX223



.30-06 BROKEN SHELL EXTRACTOR

TL-EX306



7.62X39 BROKEN SHELL EXTRACTOR

TL-S001



10/22 STEEL EXTENDED MAGAZINE RELEASE

TL-MGRL22A

- Steel Construction with Matte Black Type III Hard Coat Anodize
- Increases the Speed and Ease of Releasing Magazines with Confidence
- User Friendly Installation



UNIVERSAL SHOTGUN FOREND WRENCH

TL-SHWR01

- Nickel Plated Steel Alloy Construction
- User Friendly with Ergonomic Comfortable Handles for Easy Forend Removal and Installation
- Compatible with Remington 870, Mossberg 500A/C, 835 and Other Variants



BIPOD SWIVEL STUD KIT

TL-BPAD1

- Converts Swivel Stud into 1-slot Picatinny Rail for Bipod Installation
- Provides Alternative Swivel Stud for Sling Swivel Attachment





QUICK DETACH SLING SWIVELS | SLING SWIVEL ADAPTORS

STANDARD PUSH BUTTON QD SLING SWIVELS

- Made from High Strength Steel with Matte Black Type III Hard Coat Anodize
- Precisely Machined for Proper Fit and Reliable Function



TL-QDSW08A



TL-QDSW08B



TL-QDSW08C

1/3" HEAVY DUTY PUSH BUTTON QD SLING SWIVELS

- Made from High Strength Steel with Matte Black Type III Hard Coat Anodize
- Precisely Machined for Proper Fit and Reliable Function



TL-QDSW18



TL-QDSW28

Compatible with the Following UTG and UTG PRO Products

- MTU001 • MTU015 • MNT-BR005 • MNT-BR005XL
- MTU003 • MTU018 • MNT-BR101TR-A • MNT-BR003XL
- MTU007 • MTU001T • MNT-BR002

PICATINNY MOUNT QD SWIVEL 1 1/4" LOOP

- Precision Machined Aluminum/steel Construction with Matte Black Type III Hard Coat Anodize
- Solid Steel 1.25" Sling Loop Compatible with Most Slings on the Market
- Tool Free Locking Thumb Nut



TL-SWMTPO1

MODEL 4 RECEIVER EXTENSION TUBE AMBIDEXTROUS SLING ADAPTOR MOUNT

- User Friendly Installation, Wraps Around Extension Tube without the Need to Disassemble or Modify Your Firearm
- Constructed of Hardened and Casted Steel with Matte Black Type III Hard Coat Anodize
- Compatible with Both Mil-spec and Commercial-spec Extension Tubes
- Provides Ambidextrous Sling Use



TL-SWR02



TL-SWR01

★
TL-QDSW08A
INCLUDED

SPECIFICATIONS

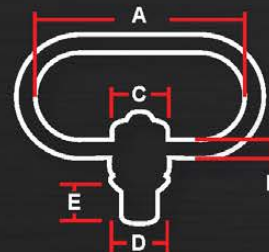

Item Number	A Loop Width	B Loop Thickness	C Push Button Diameter	D Stud Diameter	E Stud Height
TL-QDSW08A	1.09"	0.13"	0.47"	0.37"	0.35"
TL-QDSW08B	1.25"	0.13"	0.47"	0.37"	0.35"
TL-QDSW08C	1.29"	0.13"	0.47"	0.37"	0.35"
TL-QDSW18	1.38"	0.17"	0.60"	0.37"	0.37"
TL-QDSW28	1.38"	0.17"	0.17"	0.37"	0.47"
TL-SWMTPO1	1.25"	0.17"	N/A	N/A	N/A
TL-SWR01	1.25"	0.13"	N/A	N/A	N/A
TL-SWR02	1.09"	0.13"	0.47"	0.37"	0.35"



QUICK DETACHABLE M-LOK™ AND KEYMOD COMPATIBLE SLING SWIVEL ADAPTORS AND PLATES



NEW!



NEW!



NEW!

UTG PRO MADE IN M-LOK™ QD SLING SWIVEL ADAPTOR

TLUSW001

- Precision Machined from Aircraft Grade Aluminum with Matte Black Type III Hard Coat Anodize
- Lightweight, Low Profile Design Uses the Least Amount of Space M-LOK™ Requires While Retaining Optimum Mounting Performance
- Adaptor Bi-directionally Mounts and Efficiently Utilizes Rail Real Estate by Mounting Either In One Slot or in Between Adjacent Slots on the Same Track
- Accepts Any Quick Detach Sling Swivel with 0.37" Diameter Swivel Stud
- QD Swivel Housing Designed with Quarter-turn Rotational Over Travel Stops to Restrict Swivel Movement and Prevent Sling from Getting Tangled
- Includes M-LOK™ T-Nuts, Screws, and Allen Wrench for Simple and User Friendly Installation, No Gunsmith Required

UTG PRO MADE IN KEYMOD COMPATIBLE QD SLING SWIVEL ADAPTOR

TLUSW002

- Precision Machined from Aircraft Grade Aluminum with Matte Black Type III Hard Coat Anodize
- lightweight and Low Profile Design Keeps Added Bulk to a Minimum and Without Creating an Additional Snag Point
- Accepts Any Quick Detach Sling Swivel with 0.37" Diameter Swivel Stud
- QD Swivel Housing Designed with Quarter-turn Rotational Over Travel Stops to Restrict Swivel Movement and Prevent Sling from Getting Tangled
- Includes Keymod Nuts, Screws, and Allen Wrench for Simple and User Friendly Installation, No Gunsmith Required

LOW PROFILE ANGLED QD SLING SWIVEL PICATINNY ADAPTOR

TL-SWPM01

- Low Profile and Lightweight Design with 45 Degree Offset Optimizing installation at the 12 O'clock Handguard Position
- Accepts Standard Quick Detach Push Button Sling Swivel with 0.37" Diameter
- Precision Machined from Aircraft Grade Aluminum with Matte Black Type III Hard Coat Anodize
- Simple and User Friendly Installation, No Gunsmith Required



MODEL 4 RECEIVER END PLATE AMBIDEXTROUS SLING ADAPTOR

TL-T6TD02

- Steel Construction with Matte Black Type III Hard Coat Anodize
- Left and Right Sling Loop Accommodate Both Strap and Hook Type Sling Applications
- Compatible with Both Mil-spec and Commercial-spec Extension Tubes
- Compatible with Most Sling Hooks on the Market



KEYMOD COMPATIBLE QD SLING SWIVEL ADAPTOR

TL-SWKM01

- lightweight and Low Profile Design Keeps Added Bulk to a Minimum and Without Creating an Additional Snag Point
- Accepts Any Standard Quick Detach Sling Swivel with 0.37" Diameter Push Button
- Precision Machined from Aircraft Grade Aluminum with Matte Black Type III Hard Coat Anodize

NEW!



PICATINNY/KEYMOD COMPATIBLE QD SLING SWIVEL ADAPTOR

TL-SWPK01

- Innovative, Compact, and Lightweight Design Adaptable for Installation on Both Picatinny or Keymod Compatible Rails
- Accepts Standard Quick Detach Push Button Sling Swivel
- Precision Machined from Aircraft Grade Aluminum with Matte Black Type III Hard Coat Anodize
- Complete with Made in USA Installation Screws, Stainless Steel Keymod Nuts, and Allen Wrench



CLEANING KITS

.223/5.56M CLEANING KIT

TL-A042

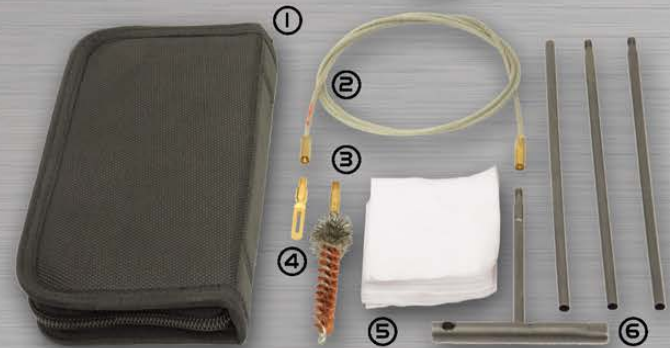
NEW!

1. Nylon Pouch
2. Cleaning Cable
3. Chamber Brush

4. Patch Loop
5. Cleaning Patches
6. T-handle and 3 Rod extensions

This kit contains all the tools you need to clean your .223/5.56mm rifles, including such platforms as the AR15, Mini 14, Steyr Aug, Kel-Tec SU-16, Beretta AR70, Saiga, M96 and others. It includes a cleaning cable, chamber brush, patch loop, cleaning patches, t-handle, and 3 rod extensions. All of the parts conveniently store within the included carrying case.

.223/5.56 CLEANING KIT

TL-A041



1. Oil Bottle
2. Bore and Chamber Brush
3. Nylon Pouch with 2 Pockets
4. Belt Loop/Alice Clip Attachment

5. Dual-ended Nylon Brush
6. Adaptor and Patch Loop
7. T-handle and 3 Rod Extensions
8. Cleaning Patches

This kit contains all the tools you need to clean your .223/5.56mm rifles, including such platforms as the AR15, Mini 14, Steyr Aug, Kel-Tec SU-16, Beretta AR70, Saiga, M96 and others. It includes a 5-extension steel cleaning rod with adaptor, patch loop, bronze bore brush, chamber brush, double-ended nylon Utility brush, ½ oz oil bottle, and cleaning patches. All parts conveniently store within the included OD green nylon pouch with belt loop and alice clip attachment point. equipped with two hook and loop closure pockets and external snap button flap.

9MM PISTOL CLEANING KIT

TL-CLP9MMKT



1. Cleaning Rod
2. Patch Loop
3. Bronze Bore Brush

4. Nylon Bore Brush
5. Cotton Mop Brush

A compact and practical cleaning kit for .38/.357 and 9mm handguns. Conveniently stows away in any range bag in its own organized polymer case (4 5/8" X 2 7/8" X 1 1/2"). The kit includes an 8-32 threaded copper alloy cleaning rod with the following threaded cleaning accessories: patch loop, bronze and nylon brush, and a cotton mop. The cleaning rod is interchangeable with all other accessories on the market with 8-32 threads.

1-PACK .223/5.56MM CHAMBER BRUSH

TL-CLCB223

.22/5.56mm Chamber Brush with Bronze and Stainless Bristles, Thread 8-32



3-PACK .22 CAL. BORE BRUSHES

TL-CLBR223

3-pack .22/5.56mm Bore Brushes (Bronze, Cotton, and Nylon), Thread 8-32



3-PACK .30 CAL. BORE BRUSHES

TL-CLBR308

3-pack .30/31 Cal. Bore Brushes (Bronze, Cotton, and Nylon), Thread 8-32



3-PACK 9MM BORE BRUSHES

TL-CLBR9MM

3-pack 9mm/.38/.357 Bore Brushes (Bronze, Cotton, and Nylon), Thread 8-32



3-PACK .45 ACP BORE BRUSHES

TL-CLBR45

3-pack .44/.45 Cal. Bore Brushes (Bronze, Cotton, and Nylon), Thread 8-32



3-PACK 20 GA. BORE BRUSHES

TL-CLBRGA20

3-pack 20 Ga. Bore Brushes (Bronze, Cotton, and Tornado), Thread 5/16-27



3-PACK 12 GA. BORE BRUSHES

TL-CLBRGA12

3-pack 12 Ga. Bore Brushes (Bronze, Cotton, and Tornado), Thread 5/16-27

