



UTG PRO
MADE IN USA

UTG PRO



MOUNTING SYSTEMS

MODULARITY REDEFINED

UTG PRO® and UTG® mounting systems and components have everything you need to kit up your long gun for recreation, sporting, defense, and more. For the AR platform, we have the options to tailor to your rifle to the T with multiple different drop-in or free-float handguards options of various lengths and modular system compatibility. Our M-LOK® free-float Super Slim SD series takes everything loved from our Super Slim handguards, but with a suppressor compatible inner diameter. Forerunner handguards feature a completely new aesthetic and reduced Picatinny top rail while being our lightest handguard series to date. Popular on A2 fixed front sight builds, our drop-in Super Slim and quad rail handguards are a go-to for users looking for affordability without compromise and ease of installation with no permanent modification required.

JUMP TO A SERIES

AR15 FREE FLOAT HANDGUARDS.....Page 070	SKS MOSIN NAGANT MOUNTS..... Page 098
AR308 FREE FLOAT HANDGUARDS.....Page 088	SHOTGUN MOUNTS..... Page 099
OP3 MICRO RMR® T1 MRO® MOUNTS....Page 090	M14® M1 10/22® MOUNTS..... Page 100
SUPER SLIM RISER MOUNTS.....Page 092	MP5 G3 G36 MOUNTS..... Page 101
UNIVERSAL ANGLED RISER MOUNTS.....Page 093	UNIVERSAL RIFLE SHOTGUN MOUNTS..... Page 102
AK MOUNTS.....Page 094	AIR RIFLE MOUNTS..... Page 103

(Third party trademarks may be used in this catalog for the convenience of customers to indicate the fit or compatibility of the applicable Leapers items.)

LEAPERS, INC.
THE BEST NEVER REST
LIFETIME WARRANTY

NEW AND MUST HAVE PRODUCTS FOR 2021

**SUPER SLIM M-LOK® FOREND
FOR RUGER® PC CARBINE™**



**AR15 FORERUNNER FREE FLOAT
M-LOK® HANDGUARDS**

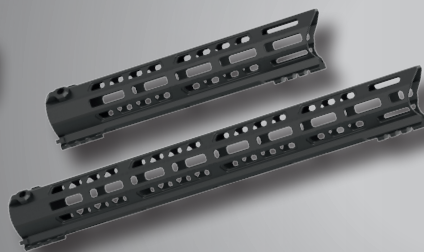

**AR15 ARWEN FREE FLOAT
M-LOK® HANDGUARDS**



**SUPER SLIM M-LOK® AK
HANDGUARD**





FREE-FLOAT AR15 HANDGUARDS

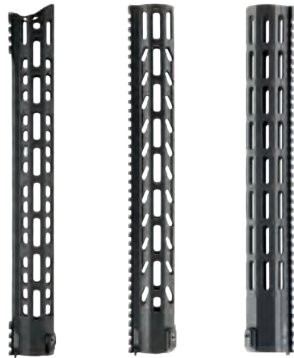

**HANDGUARDS FOR
PC CARBINE™ | RUGER
PRECISION® RIFLE | MR556A1**

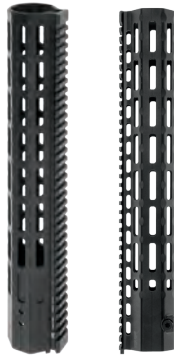

DROP-IN AR15 HANDGUARDS



**AR308
HANDGUARDS**



**RISERS FOR
OP3 MICRO | RMR® | MRO® | T1**



PAGE RANGE

UTG PRO® AR15 Forerunner Free Float M-LOK® Handguards.....070-071
 UTG PRO® AR15 Arwen Free Float M-LOK® Handguards.....072-073
 UTG PRO® AR15 Super Slim SD Free Float M-LOK® Handguards.....074-075
 UTG PRO® AR15 Ultra Slim Free Float M-LOK® Handguards.....078-079
 UTG PRO® AR15 Super Slim Free Float Handguards080-081
 UTG PRO® AR15 2-Tone Super Slim Free Float M-LOK® Handguards.....082

UTG PRO® Super Slim M-LOK® Forend for Ruger® PC Carbine™076
 UTG PRO® Super Slim Free Float Handguards for Ruger Precision® Rifle.....077
 UTG PRO® Super Slim M-LOK® Free Float Handguard for HK® MR556A1.....083

UTG PRO® AR15 Drop-In Super Slim Handguards.....084-085
 UTG PRO® AR15 Drop-In Quad Rail Handguards.....086-087

UTG PRO® AR308 Super Slim Free Float Handguards.....088-089

OP3 Micro Reflex Dot Sight Super Slim Mounts.....090
 Super Slim Mounts for RMR® | T1 | MRO®091
 Universal Super Slim Riser Mounts.....092
 Universal Riser Mounts.....093

HIGHLIGHTS

Take a look at our vast lineup of free-float handguards for the AR15 MSR available in multiple lengths, different feature sets, and various finishes in the M-LOK®, Keymod, Standard Super Slim, or MIL-STD-1913 Picatinny modular systems. Check out our 3 new UTG PRO® M-LOK® handguard series: The Forerunner, Arwen, and Super Slim SD, featuring our new one-piece steel or titanium barrel nut system requiring little to no timing during installation.

New products include our Drop-in Super Slim Ruger® PC Carbine™ M-LOK® handguard featuring fully melted contours with its edges chamfered and corners dehorned for a comfortable, versatile, and lightweight addition to your Ruger® PC Carbine™.

Take a look at our extensive lineup of drop-in handguards for the AR15 MSR. We have multiple length options to accommodate MSRs with either a carbine-length, mid-length, or rifle-length direct impingement gas system. Handguards are available in M-LOK®, Keymod, or MIL-STD-1913 Picatinny modular systems and require no permanent modification during installation.

Super Slim Handguards available in both M-LOK® and Keymod featuring the same design implementations and feature sets as their AR15 MSR counterparts.

A plethora of both dedicated and universal mounts and risers for installation on MIL-STD-1913 Picatinny equipped rifles or rear sight dovetails of pistols. Multiple heights available to include heights for absolute co-witness, lower 1/3 co-witness, low profile, and more

APPLICATIONS

- Direct Impingement AR Platform

- HK® MR556A1
- Ruger® Precision® Rifle
- Ruger® PC Carbine™

- Direct Impingement AR Platform

- S&W M&P®10
- DPMS® LR-308 and GII
- Armalite® AR-10®
- Clones

- Modern Sporting Rifles
- Pistols
- Shotguns
- AR Pistols
- Pistol Caliber Carbines

SUGGESTED USES







- Individual Patrol Rifles
- Home Defense
- Recreational
- Competition

- Sport Shooting & Competition
- Long Range Precision
- Defense Agencies
- Custom Builds
- Home and Personal Defense
- Recreational

- Large Scale Governmental Contracts
- Departmental & Agency Rifles
- Individual Patrol Rifles
- Home Defense
- Recreational

- Sport Shooting & Competition
- Long Range Precision
- Defense Agencies
- Custom Builds
- Recreational

- Sport Shooting & Competition
- Defense Agencies
- Custom Builds
- Home and Personal Defense
- Recreational
- Non-magnified Optics Installation
- Optics-ready Pistols

AK HANDGUARDS & MOUNTS	SKS MOSIN MOUNTS	SHOTGUN MOUNTS	MOUNTS FOR M14® M1 10/22®	MOUNTS FOR MP5 G3 G36	ANGLE & BARREL MOUNTS	AIR RIFLE MOUNTS
						
<p>UTG PRO® AK Super Slim Keymod Handguards.....094-095</p> <p>UTG PRO® M92 Quad Rail Handguard096</p> <p>UTG PRO® Romanian/Chinese/US AK Quad Rail System096</p> <p>UTG PRO® AMD-65 Quad Rail System096</p> <p>UTG PRO® YUGO AK Quad Rail System096</p> <p>UTG PRO® AK Quick Detach Side Mount097</p> <p>UTG® AK Steel Side Plate097</p> <p>UTG PRO® AK QD Low Profile Top Rail System097</p>	<p>UTG PRO® SKS Receiver Cover with Integrated Picatinny Rail and Shell Deflector.....098</p> <p>Mosin Nagant Tri-rail Mount098</p>	<p>UTG® Optic Mount for 590®/ 590M®099</p> <p>UTG® Optic Mount for Remington® 870™099</p> <p>UTG PRO® Optic Mount for Mossberg® 500®099</p> <p>UTG PRO® Optic Mount for Remington® 870™099</p>	<p>Scope Mount for Locking M14/M1A™100</p> <p>M1 Carbine Mount Complete With 1" Rings100</p> <p>Scout Rail for Ruger® 10/22® Rifles100</p> <p>UTG PRO® Low Profile Scope Mount For Ruger® 10/22® Rifles100</p> <p>Scope Mount for Remington® 700® Long Action Rifles100</p> <p>Scope Mount for Remington® 700® Short Action Rifles100</p>	<p>MP5 G3 Low Profile Claw Mount.....101</p> <p>MP5 G3 Steel Claw Mount101</p> <p>G36 Carry Handle Scope Mount101</p> <p>G36 Picatinny Rail Sets101</p>	<p>Universal Rifle Barrel Mounts102</p> <p>Universal Shotgun Barrel Mounts102</p>	<p>PCP Tank Rail Adaptor.....103</p> <p>Universal Dovetail to Picatinny Rail Adaptor.....103</p> <p>Dovetail to Picatinny Adaptor Mount103</p> <p>Compensation Mount for T06 Tigger Equipped RWS Diana Air Rifles103</p> <p>Dovetail-to-Picatinny Snap-in Rail Adaptor.....103</p>
<p>Continuing our lineage of AK handguards, mounts, and accessories, make sure you stop and see our series of Super Slim Keymod Drop-in handguards. Available in three different lengths for a variety of different AK platform variants, the lightweight, sleek, and modular Super Slim puts personalization in mind without the added bulk and weight</p>	<p>In order to satisfy our need to be your one stop shopping solution. We make it a very important note to keep stock of classic mounts not easily found in today's markets. Customers will continue to enjoy from us mounts and accessories made for the venerable SKS and Mosin Nagant</p>	<p>Still very much prevalent in the shooting community, Saiga 12s and more traditional shotguns are still considered a staple with us. Continue to enjoy a variety of different optic mounts and handguards for these staples.</p>	<p>Here you will find a garden variety of different mounts and accessories for the aforementioned platforms. Several different solutions are available to quickly and easily mount optics and accessories without the need for permanent modification or a gunsmith.</p>	<p>Enjoy various scope and accessory mounting options for these classics here. Simple, affordable, and quality solutions for these fan favorites.</p>	<p>Universal MIL-STD-1913 Picatinny mounts ideally used for adding accessories onto firearms that lack mountable handguards, flat tops, etc. Universal Barrel mounts offer quick solutions for adding a bipod or flashlight to traditional firearms not equipped with MIL-STD-1913 Picatinny rails.</p>	<p>We enjoy plinking just as much as the rest of you and value the importance of getting an optic set up just right on an air rifle. Look here for our barrel droop compensating mounts, dovetail to Picatinny adaptor, universal dovetail scope mount, and our new PCP tank Picatinny rail adaptors.</p>
<ul style="list-style-type: none"> • USA Made AK and Clones • Romanian/Chinese Made AK and Clones • Yugoslavian Made AK and Clones • Hungarian Made AMD-65 and Clones 	<ul style="list-style-type: none"> • SKS Rifle and Clones • Mosin Nagant Rifles 	<ul style="list-style-type: none"> • Saiga 12 Semi-Auto Shotgun • Mossberg® 500® Pump Action Shotgun • Remington® 870™ Pump Action Shotgun 	<ul style="list-style-type: none"> • M1 Carbine • M1A™ & M14® Rifles • 10/22® Rifles • Remington® 700® Rifles 	<ul style="list-style-type: none"> • MP5 and Clones • G3 Rifles and Clones • G36 Rifles and Clones 	<ul style="list-style-type: none"> • Firearms with MIL-STD-1913 Picatinny • Firearms without MIL-STD-1913 Picatinny 	<ul style="list-style-type: none"> • Airguns with 9mm-11mm Dovetail Rails
<ul style="list-style-type: none"> • Defense Agencies • Custom Builds • Recreational • Home and Personal Defense 	<ul style="list-style-type: none"> • Long Range Precision • Custom Builds • Recreational • Hunting • 922R Compliance 	<ul style="list-style-type: none"> • Custom Builds • Recreational • Home and Personal Defense • Law Enforcement Agencies • Hunting • 922R Compliance 	<ul style="list-style-type: none"> • Long Range Precision • Custom Builds • Recreational • Home and Personal Defense • Hunting • Plinking 	<ul style="list-style-type: none"> • Custom Builds • Recreational • Home and Personal Defense • Law Enforcement Agencies • Defense Agencies 	<ul style="list-style-type: none"> • Custom Builds • Recreational • Home and Personal Defense • Law Enforcement Agencies • Defense Agencies 	<ul style="list-style-type: none"> • Barrel Droop Compensation • Optics Installation • Bipod Installation • Recreational/Plinking • Competition • Small Game Hunting



AR15 FORERUNNER FREE FLOAT M-LOK® HANDGUARDS

MOUNTING SYSTEMS

AR15 FORERUNNER FREE FLOAT HANDGUARDS

- MADE IN USA**
- 6061-T6 ALUMINUM**
- PRECISION MACHINED**
- MIL-STD-1913 PICATINNY**
- M-LOK®**
- OCTAGONAL PROFILE**
- FREE FLOAT**
- US PAT. 10670369**
- AVAILABLE COLOR(S)**
■ Matte Black Anodized
- DIMENSION**

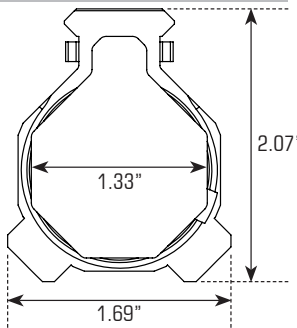

- PARTS INCLUDED**
- Barrel Nut and Wrench**
- M-LOK® 7-Slot Picatinny Rail Section & QD Sling Swivel Adaptor**
- Installation Hardware**



UTG PRO® Forerunner Free Float Handguards

- Proudly Designed and Made in the USA
- Precision Machined from 6061-T6 Aluminum and Finished in a Matte Black Hard Coat Anodization
- Unique Patented Titanium Barrel Nut Requires Little to No Timing in Relation to the Gas Tube and Installation Screws
- M-LOK® Slots on 3 Slot Tracks for Mounting Accessories
- Handguard Features an Ergonomic Octagonal Profile and Machined Lightening Cuts Made Throughout with a 3-Slot Top Picatinny Rail Found at the Front and Rear
- Integral Anti-rotation Tabs for Accurate Alignment with Upper Receiver and to Prevent Unintentional Handguard Rotation and Flex
- Compatible with Left or Right Handed Standard Mil-Spec AR15 Upper Receivers
- Includes M-LOK® Picatinny Rail Section, QD Sling Swivel Adaptor, Installation Hardware, and Barrel Nut Wrench

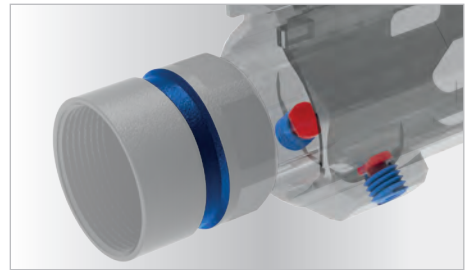

Barrel Nut Features a Precisely Machined Indexing Channel around its Circumference Requiring Little to No Timing with the Handguard's Locking Screws When Properly Torqued

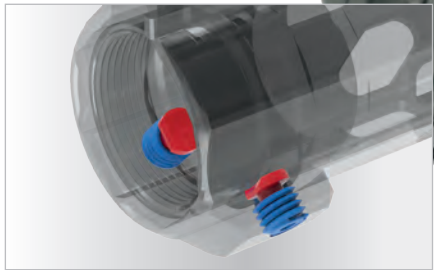

Handguard Secures to Barrel Nut Simply by Tightening the Locking Screws to their Proper Torque Value



Locking Tabs, Integrated within the Locking Screws, Index Against the Barrel Nut's Channel After Being Tightened, Creating a Rigid 4-Point Steel-on-Steel Lockup



Titanium Barrel Nut Compatible with Bull Barrels up to Ø1.05" and Requires Little to No Timing



Integral Anti-rotation Tabs



Left and Right Handed Receiver Compatible



Reinforced Steel Helicoil Thread Inserts

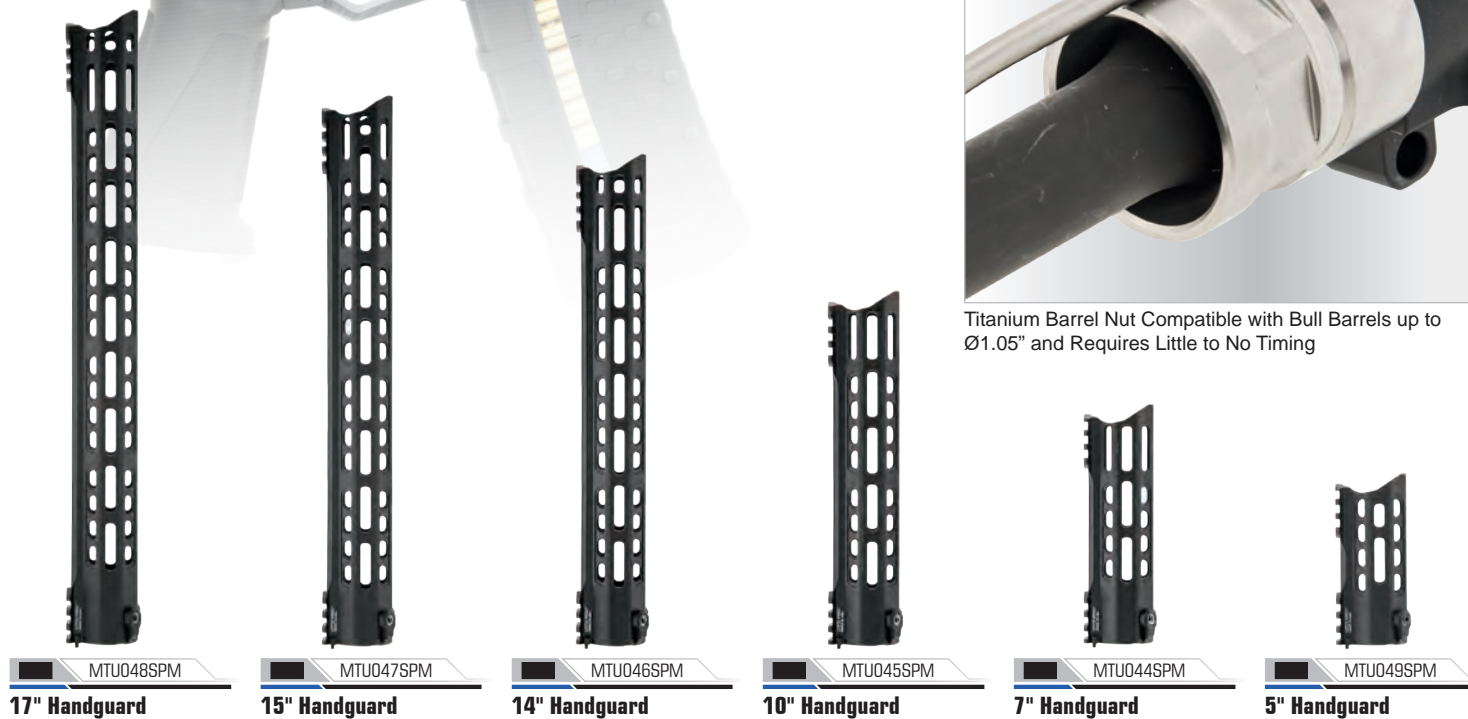

MTU048SPM

17" Handguard

MTU047SPM

15" Handguard

MTU046SPM

14" Handguard

MTU045SPM

10" Handguard

MTU044SPM

7" Handguard

MTU049SPM

5" Handguard

Model #	MTU048SPM	MTU047SPM	MTU046SPM	MTU045SPM	MTU044SPM	MTU049SPM
Actual Length	17.3"	15.3"	13.8"	9.8"	6.8"	4.8"
M-LOK® Slots	31 Full, 7 Half	28 Full, 3 Half	25 Full, 7 Half	19 Full	13 Full	3 Full, 3 Half
Top Picatinny Slots	6	6	6	6	6	6
Net Weight	11.5 oz	10.3 oz	9.5 oz	7.3 oz	5.7 oz	4.6 oz
Barrel Length	18"	16"	14.5"	10.5"	7.5"	5.5"



AR15 ARWEN FREE FLOAT M-LOK® HANDGUARDS

MOUNTING SYSTEMS

AR15 ARWEN FREE FLOAT HANDGUARDS

- MADE IN USA**
- 6061-T6 ALUMINUM**
- PRECISION MACHINED**
- MIL-STD-1913 PICATINNY**
- M-LOK®**
- OCTAGONAL PROFILE**
- FREE FLOAT**
- US PAT. 10670369**
- AVAILABLE COLOR(S)**
■ Matte Black Anodized
- DIMENSION**

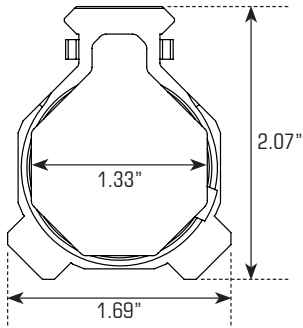

- PARTS INCLUDED**
- Barrel Nut and Wrench**
- Installation Hardware**

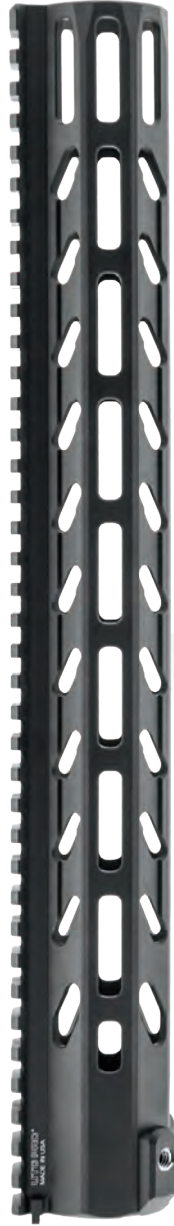

UTG PRO® Arwen Free Float Handguards

- Proudly Designed and Made in USA
- Unique Patented Steel Barrel Nut Requires Little to No Timing in Relation to the Gas Tube and Installation Screws and Furthermore, Does not Require a Proprietary Wrench for Installation
- Precision Machined from 6061-T6 Aluminum and Finished in a Matte Black Hard Coat Anodization
- M-LOK® Slots at the 3, 6, and 9 O'clock Positions along with Additional 45 Degree M-LOK® Slots Located at the Front of the Handguard
- Lightening Cuts Throughout the Handguard Keep Weight to a Minimum
- Includes Installation Hardware, and Barrel Nut Wrench



Full Length Scalloped Top Picatinny Rail

6061-T6 Aluminum Construction

Type III Class III Matte Black Hard Coat Anodized

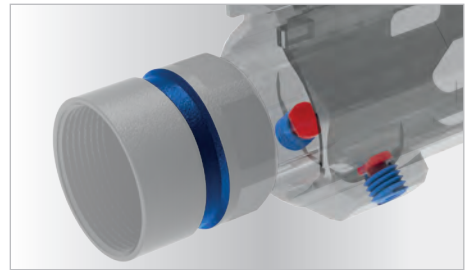

Barrel Nut Features a Precisely Machined Indexing Channel around its Circumference Requiring Little to No Timing with the Handguard's Locking Screws When Properly Torqued

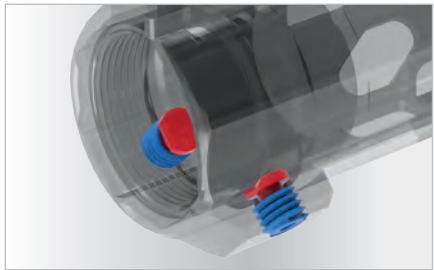

Handguard Secures to Barrel Nut Simply by Tightening the Locking Screws to their Proper Torque Value



Locking Tabs, Integrated within the Locking Screws, Index Against the Barrel Nut's Channel After Being Tightened, Creating a Rigid 4-Point Steel-on-Steel Lockup

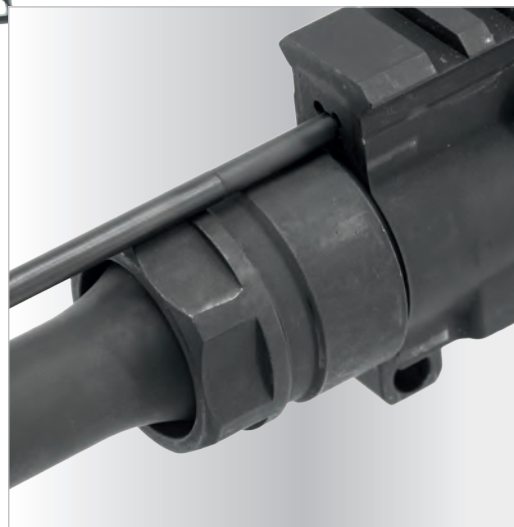

Steel Barrel Nut Compatible with Bull Barrels up to $\text{Ø}1.05$ " and Requires Little to No Timing



Integral Anti-rotation Tab



Scalloped Picatinny Rail



Reinforced Steel Helicoil Thread Inserts



MTU048SEM

17" Handguard



MTU047SEM

15" Handguard



MTU046SEM

14" Handguard



MTU045SEM

10" Handguard



MTU044SEM

7" Handguard



MTU049SEM

5" Handguard

Model #	MTU048SEM	MTU047SEM	MTU046SEM	MTU045SEM	MTU044SEM	MTU049SEM
Actual Length	17.3"	15.3"	13.8"	9.8"	6.8"	4.8"
M-LOK® Slots	34 Full	28 Full, 3 Half	25 Full, 3 Half	19 Full	13 Full	10 Full
Top Picatinny Slots	43	38	34	24	16	11
Net Weight	14.4 oz	13.1 oz	12.1 oz	9.4 oz	7.4 oz	6.0 oz
Barrel Length	18"	16"	14.5"	10.5"	7.5"	5.5"



AR15 SUPER SLIM SD FREE FLOAT M-LOK® HANDGUARDS

MOUNTING SYSTEMS

AR15 SUPER SLIM SD FREE FLOAT HANDGUARDS

- MADE IN USA
- 6061-T6 ALUMINUM
- PRECISION MACHINED
- MIL-STD-1913 PICATINNY
- M-LOK®
- OCTAGONAL PROFILE
- FREE FLOAT
- SUPPRESSOR COMPATIBLE
- US PAT. 10670369
- AVAILABLE COLOR(S)
■ Matte Black Anodized
- DIMENSION

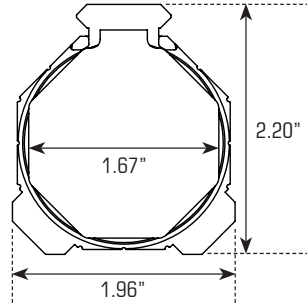

- PARTS INCLUDED
- Barrel Nut and Wrench
- M-LOK® 7-Slot Picatinny Rail Section & QD Sling Swivel Adaptor
- Installation Hardware



UTG PRO® Super Slim SD Free Float Handguards

- Proudly Designed and Made in the USA
- 1.67" Inner Diameter for Compatibility with Suppressors
- Precision Machined from 6061-T6 Aluminum and Finished in a Matte Black Hard Coat Anodization
- M-LOK® Slots on 7 Slot Tracks for Mounting Accessories
- Ergonomic Octagonal Profile with Grooved Surface Provides a Comfortable Means of Handling
- Full Length Top Picatinny Rail is Flush and Continuous with Upper Receiver
- Features Integral Anti-rotation Tabs for Accurate Alignment with Upper Receiver and to Prevent Unintentional Handguard Rotation and Flex
- Compatible with Left or Right Handed Standard Mil-Spec AR15 Upper Receivers
- Includes M-LOK® Picatinny Rail Section, QD Sling Swivel Adaptor, Installation Hardware, and Barrel Nut Wrench

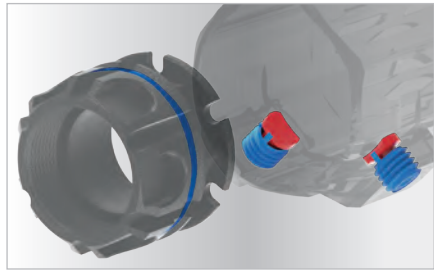

Barrel Nut Features a Precisely Machined Indexing Channel around its Circumference

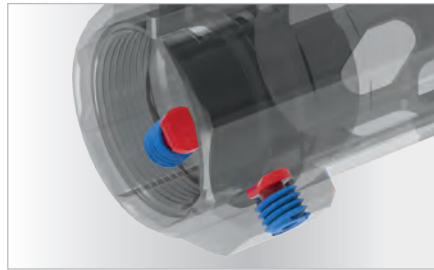

Handguard Secures to Barrel Nut Simply by Tightening the Locking Screws to their Proper Torque Value

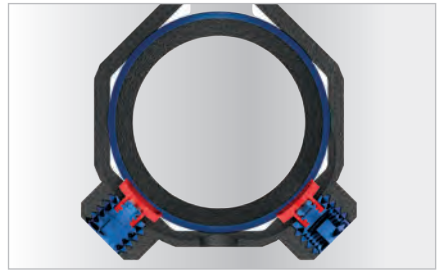

Locking Tabs, Integrated within the Locking Screws, Index Against the Barrel Nut's Channel After Being Tightened, Creating a Rigid 4-Point Steel-on-Steel Lockup



MTU047XLM
16" Handguard



MTU046XLM
14" Handguard



MTU045XLM
10" Handguard



MTU044XLM
7" Handguard



Steel Barrel Nut Compatible with Bull Barrels up to Ø1.05"



1.67" Inner Diameter



Integral Anti-rotation Tabs



Reinforced Steel Helicoil Thread Inserts

Model #	MTU047XLM	MTU046XLM	MTU045XLM	MTU044XLM
Actual Length	15.5"	14"	10"	7"
M-LOK® Slots	56	49	35	21
Top Picatinny Slots	38	34	24	16
Net Weight	18.3 oz	17.1 oz	13.7 oz	11.4 oz
Barrel Length	16"	14.5"	10.5"	7.5"
Inner Diameter	1.67"	1.67"	1.67"	1.67"



SUPER SLIM M-LOK® FOREND FOR RUGER® PC CARBINE™

MOUNTING SYSTEMS

SUPER SLIM M-LOK® FOREND RUGER® PC CARBINE™

- MADE IN USA**
- 6061-T6 ALUMINUM**
- PRECISION MACHINED**
- M-LOK®**
- AVAILABLE COLOR(S)**
Matte Black Anodized
- DIMENSION**

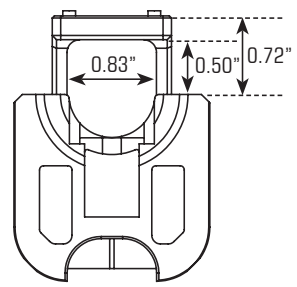

PARTS INCLUDED



Matte Black Anodized
6061-T6 Aluminum

Lightening Cuts throughout
Reduce Overall Weight

Melted Contours,
Chamfered Edges,
and Dehorned Corners

Included Lower 1/3 Co-witness
Optic Mount Utilizes Common
Docter® Footprint

M-LOK® Slots at the 3,
6, 9 O'clock Positions

Optional Accessories



NEW

TLUMD03

UTG PRO® Stubby Muzzle Brake
[Also Refer to P. 148]

NEW MTU050SSM 6.5" Forend

Model #	MTU050SSM
Length	6.5"
M-LOK® Slots	8
Overall Length:	6.49"
Overall Width:	1.80"
Overall Height"	1.73" with Optic Mount 3.45"
Net Weight	10.9 oz



UTG PRO® Super Slim M-LOK® Forend for Ruger® PC Carbine™

- Proudly Designed and Made in the USA
- Precision Machined from 6061-T6 Aluminum and Finished in a Matte Black Anodization
- Machined Lightening Cuts Throughout Forend Keep Weight to a Minimum
- 8 M-LOK® Slots, 3 Slots at 3 and 9 O'clock and 2 Slots at 6 O'clock
- Melted Contours, Chamfered Edges, and Dehorned Corners
- Optional Lower 1/3 Co-witness Docter® Footprint Optic Mount Included



NEW

RBT-GL933

33 Round Polymer Magazine for Glock®
9mm Double-stack
[Also Refer to P. 134]



SUPER SLIM FREE FLOAT M-LOK® HANDGUARD FOR RUGER PRECISION® RIFLE



MADE IN USA



6061-T6 ALUMINUM



PRECISION MACHINED



MIL-STD-1913 PICATINNY



OCTAGONAL PROFILE



FREE FLOAT



US PAT. 8806792



DIMENSION

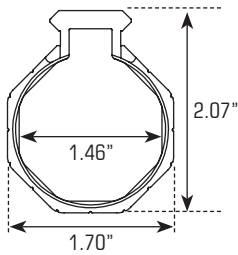

AVAILABLE COLOR(S)

Matte Black Anodized



PARTS INCLUDED

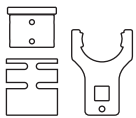

Barrel Nut, Locking Ring, and Barrel Nut Wrench

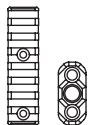

M-LOK® Model: 8-Slot Picatinny Rail Section & QD Sling Swivel Adaptor

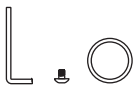

Installation Hardware



UTG PRO® Super Slim Free Float M-LOK® Handguard For Ruger Precision® Rifle

- M-LOK® Slots on 7 Tracks
- Super Lightweight with 36 Slot Picatinny Top Rail, Flush Fitting, and Continuous with Receiver
- Not Compatible with Magnum Caliber Models

Scalloped Top Picatinny Rail Edges for Snag Free Accessory Mounting

Ergonomic Finger Grooves for a Solid and Comfortable Grip



MTU041SSM
15" Handguard

Model #	MTU041SSM
Length	15.0"
M-LOK®	49
Top Picatinny Slots	36
Net Weight	19.1 oz



Flush Fitting and Continuous with Receiver



Integral Anti-rotation Tabs for Accurate Alignment with Receiver

MOUNTING SYSTEMS

SUPER SLIM FREE FLOAT HANDGUARD FOR RUGER® RPR



AR15 ULTRA SLIM FREE FLOAT M-LOK® HANDGUARDS

MOUNTING SYSTEMS

AR15 ULTRA SLIM FREE FLOAT HANDGUARDS

- MADE IN USA**
- 6061-T6 ALUMINUM**
- PRECISION MACHINED**
- MIL-STD-1913 PICATINNY**
- OCTAGONAL PROFILE**
- FREE FLOAT**
- US PAT. 8806792**
- DIMENSION**

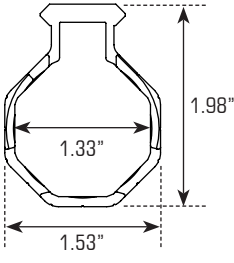

- AVAILABLE COLOR(S)**
 - Matte Black Anodized**
 - Black/Red Anodized**
 - Black/Blue Anodized**

- PARTS INCLUDED**

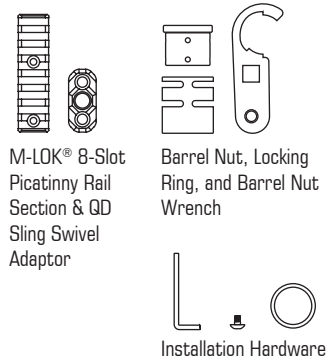

UTG PRO® AR15 Ultra Slim Free Float M-LOK® Handguards

- Ultra Slim Design with Lightening Cuts Made Throughout the Handguard to Massively Reduce Weight, While Still Allowing for a High Level of Modularity
- Ergonomically Grooved Handguard Surface and Octagonal Profile Features Left and Right Side Grip Serrations
- Simple and User Friendly Installation

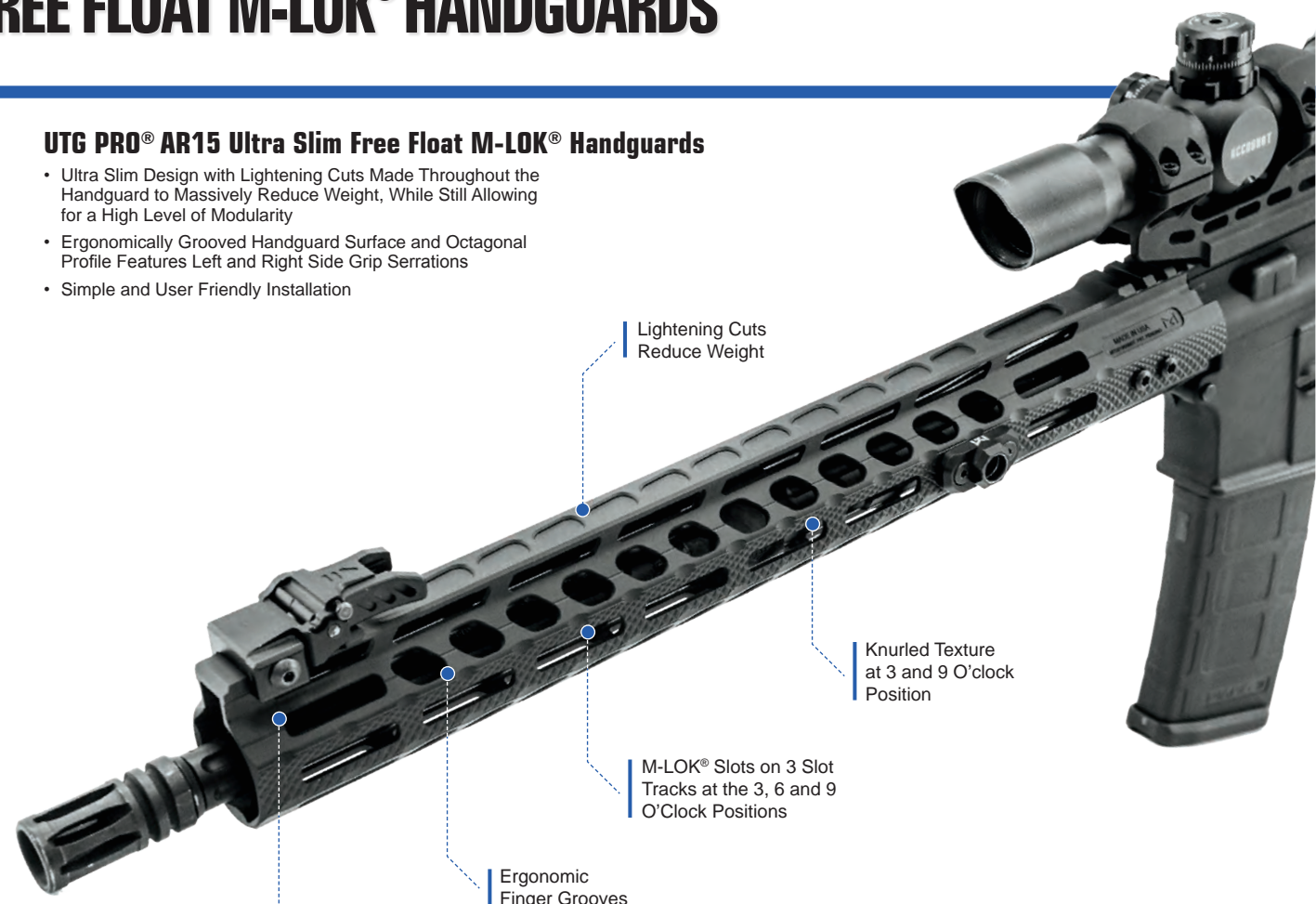

Lightening Cuts Reduce Weight

Knurled Texture at 3 and 9 O'clock Position

M-LOK® Slots on 3 Slot Tracks at the 3, 6 and 9 O'Clock Positions

Ergonomic Finger Grooves

Front and Rear End with M-LOK® Slots at the 1, 5, 7 and 9 O'Clock Positions



3-Slot Top Picatinny Rail Found at the Front and Rear of the Handguard



Compatible with Left or Right Handed Standard Mil-spec AR15 Upper Receivers



Integral Anti-rotation Tabs for Accurate Alignment with Upper Receiver



Flush Fitting and Continuous with Upper Receiver

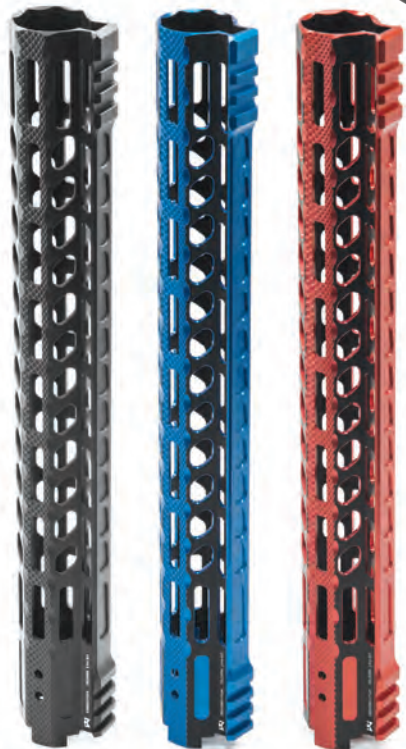

- MTU019SSM3
- MTU019SSM3B2
- MTU019SSM3R2

15" Handguard



- MTU025SSM3

10" Handguard

Model #	MTU019SSM3/B2/R2	MTU025SSM3
Length	15.3"	10.27"
M-LOK® Slots	24	15
Top Picatinny Slots	6	3
Net Weight	11.5 oz	5.9 oz

M-LOK Optional Accessories



RB-FGM01

Compact Polymer M-LOK® Foregrip
[Also Refer to P. 152]



RB-HP30M (4/PACK)

Low Profile M-LOK® Rail Panel Covers
[Also Refer to P. 157]



MT-FGM01X

Ultra Slim Foregrip
[Also Refer to P. 153]



MT-AFGM01

M-LOK® Angled Foregrip
[Also Refer to P. 150]



MT-FGM01

M-LOK® Super Slim Aluminum Vertical Foregrip
[Also Refer to P. 153]



TL-TRM01

M-LOK® Angled Index Mount
[Also Refer to P. 150]



AR15 SUPER SLIM FREE FLOAT HANDGUARDS

MOUNTING SYSTEMS

AR15 SUPER SLIM FREE FLOAT HANDGUARDS

- MADE IN USA**
- 6061-T6 ALUMINUM**
- PRECISION MACHINED**
- MIL-STD-1913 PICATINNY**
- OCTAGONAL PROFILE**
- FREE FLOAT**
- US PAT. 8806792**
- DIMENSION**

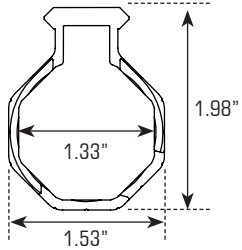

- AVAILABLE COLOR(S)**
 - Matte Black Anodized
 - FDE Cerakote®
 - Burnt Bronze Cerakote®

PARTS INCLUDED

- M-LOK® 8-Slot Picatinny Rail Section & QD Sling Swivel Adaptor**
- Keymod 4-Slot & 8-Slot Picatinny Rail Sections**
- Installation Hardware**
- Barrel Nut, Locking Ring, and Barrel Nut Wrench**

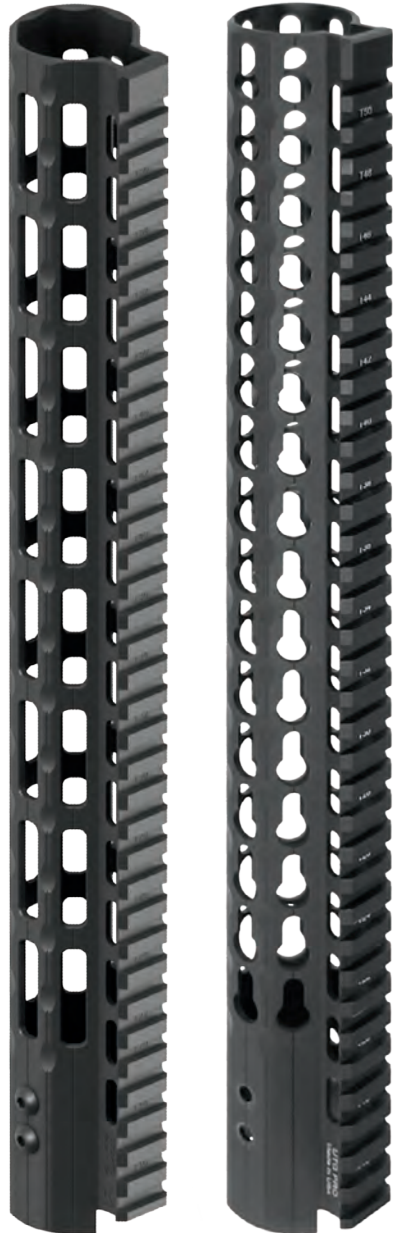

UTG PRO® AR15 Super Slim Free Float Handguards

- Ergonomic Octagonal Profile with Grooved Surface for a Solid and Comfortable Grip

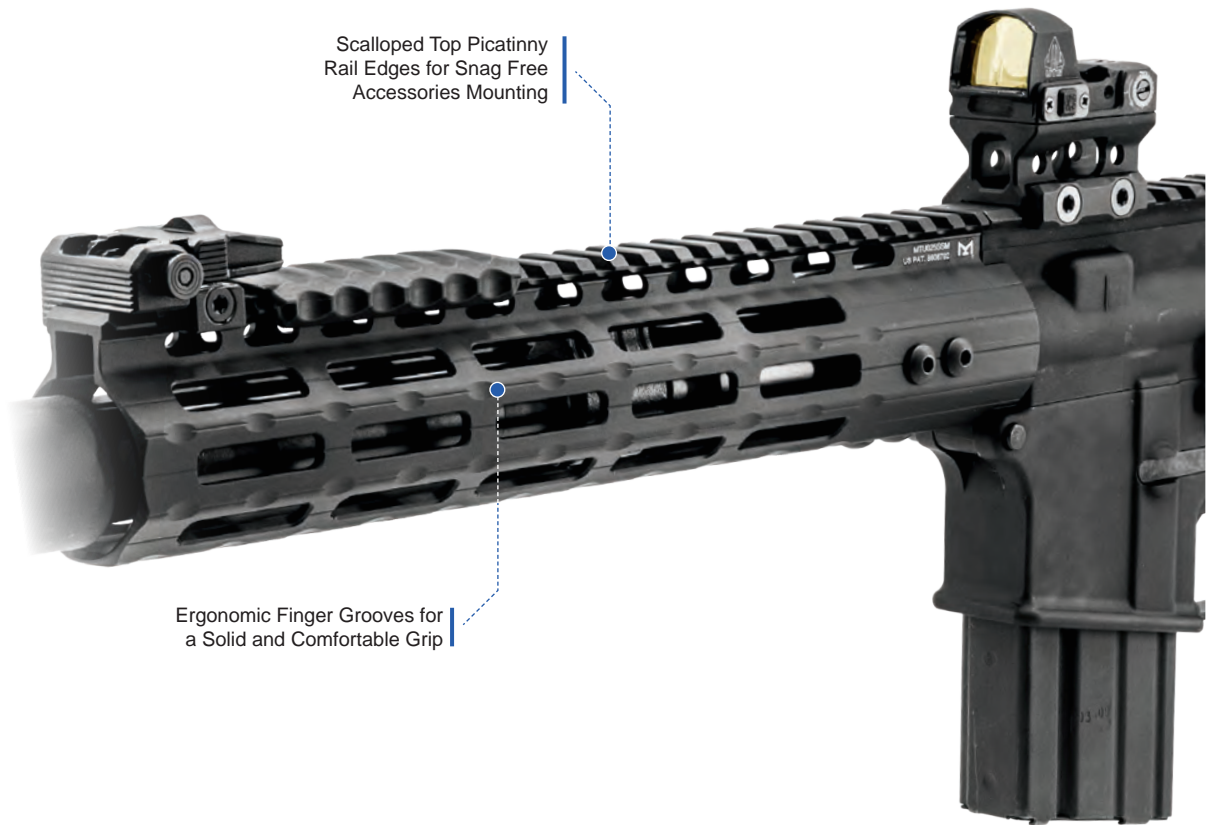

Scalloped Top Picatinny Rail Edges for Snag Free Accessories Mounting

Ergonomic Finger Grooves for a Solid and Comfortable Grip



Traditional Handguard



Super Slim Handguard



Flush Fitting and Continuous with Upper Receiver



Integral Anti-rotation Tabs for Accurate Alignment with Upper Receiver

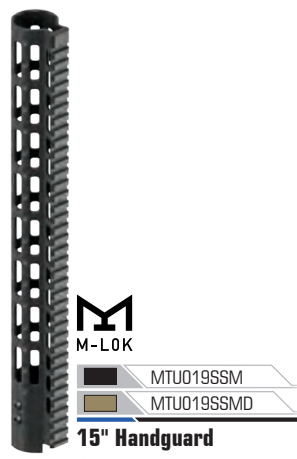

Optional Accessories
UTG PRO® Picatinny Rail Sections

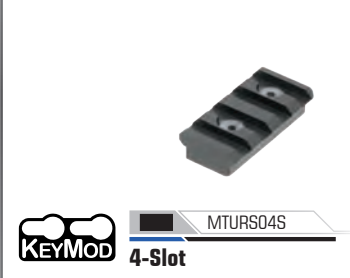
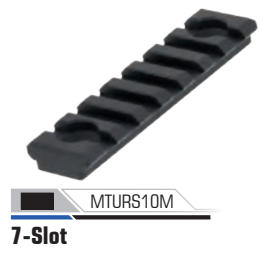

M-Lok Model #	■ MTU019SSM ■ MTU019SSMD	■ MTU006SSM	■ MTU025SSM
Length	15.3"	12.9"	10.3"
M-Lok® Slots	56	42	35
Top Picatinny Slots	37	31	25
Net Weight	12.5 oz	11.2 oz	10.2 oz

KeyMod Model #	■ MTU019SSK ■ MTU019SSKZ
Length	15.3"
Keymod Slots	112
Top Picatinny Slots	37
Net Weight	11.9 oz



AR15 2-TONE SUPER SLIM FREE FLOAT M-LOK® HANDGUARDS

MOUNTING SYSTEMS

AR15 2-TONE SUPER SLIM FREE FLOAT HANDGUARDS

- MADE IN USA**
- 6061-T6 ALUMINUM**
- MIL-STD-1913 PICATINNY**
- OCTAGONAL PROFILE**
- FREE FLOAT**
- US PAT. 8806792**
- DIMENSION**

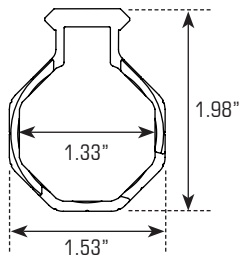

- AVAILABLE COLOR(S)**
 - Black/Red Anodized**
 - Black/Blue Anodized**
 - Black/Bronze Anodized**

- PARTS INCLUDED**

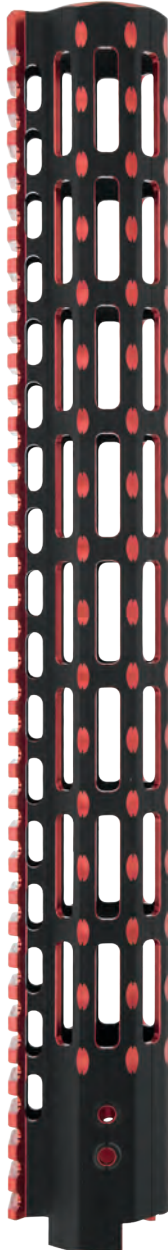
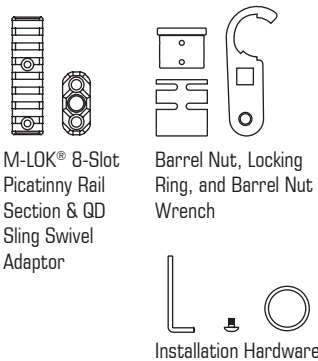

UTG PRO® AR15 2-Tone Super Slim Free Float M-LOK® Handguards

- Ergonomic Octagonal Profile with Grooved Surface for a Solid and Comfortable Grip
- M-LOK® Slots on 7 Tracks



2-TONE



Model #	MTU019SSMR2
	MTU019SSMB2
	MTU019SSMZ2
Length	15.3"
M-LOK®	49
Top Picatinny Slots	37
Net Weight	12.8 oz

Optional Accessories



Ultra Slim Handstops
[Also Refer to P. 151]

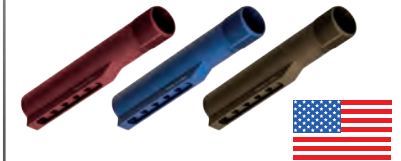

UTG PRO® AR15 Mil-Spec 6 Position Receiver Extension Tubes
[Also Refer to P. 144]



ACCU-SYNC® Offset Picatinny Scope Ring Mounts
[Also Refer to P. 058-059]



SUPER SLIM FREE FLOAT M-LOK® HANDGUARD FOR HK® MR556A1

- MADE IN USA**
- 6061-T6 ALUMINUM**
- PRECISION MACHINED**
- AVAILABLE COLOR(S)**
■ Matte Black Anodized
- MIL-STD-1913 PICATINNY**
- FREE FLOAT**
- OCTAGONAL PROFILE**
- DIMENSION**

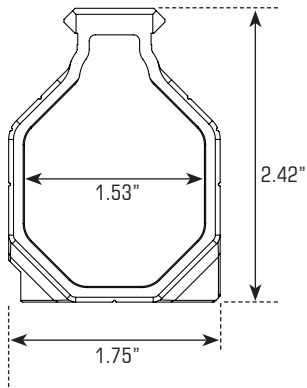

PARTS INCLUDED

- Barrel Nut Adaptor
- M-LOK® Model: 8-Slot Picatinny Rail Section & QD Sling Swivel Adaptor
- Installation Hardware

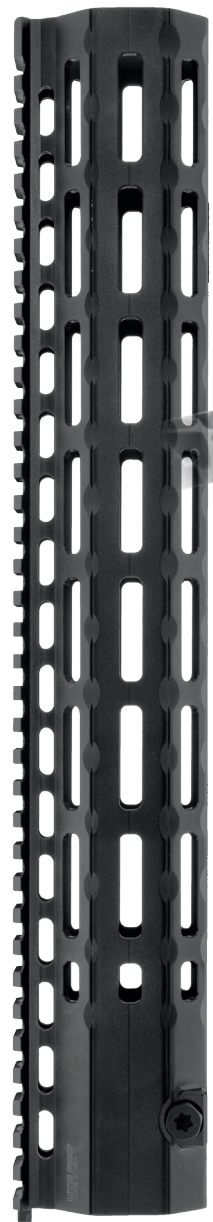

M-LOK® MTU039SSM

15" Handguard

UTG PRO® Super Slim Free Float M-LOK® Handguard for HK® MR556A1

- Scalloped Top Picatinny Rail Edges for Easy and Snag Free Accessory Mounting
- Super Lightweight with 36 Slot Picatinny Top Rail, Flush Fitting, and Continuous with Flat Top Upper Receiver
- M-LOK® Slots on 7 Tracks



Model #	MTU039SSM
Application	MR556A1
Length	14.6"
M-LOK® Slots	49
Top Picatinny Slots	36
Net Weight	12.2 oz



Utilizes Existing Barrel Nut, Integral Anti-rotation Tab, and Precision Cut Barrel Nut Shims for a Secure Installation



Flush Fitting and Continuous with Upper Receiver

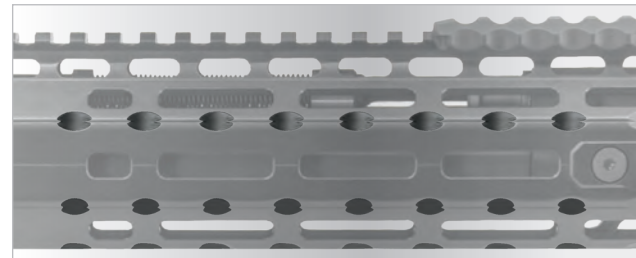

Ergonomic Finger Grooves on Rail Surface for Solid Grip and Comfort

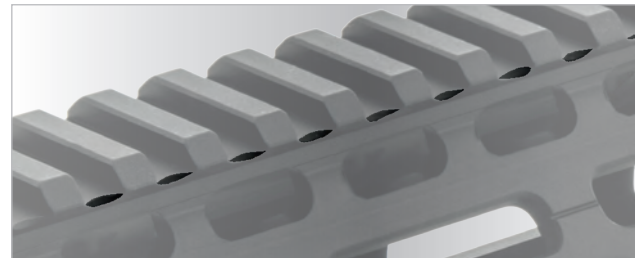

Scalloped Top Picatinny Rail Edges for Easy and Snag Free Accessory Mounting

MOUNTING SYSTEMS

SUPER SLIM FREE FLOAT HANDGUARD FOR HK® MR556A1



AR15 DROP-IN SUPER SLIM HANDGUARDS

MOUNTING SYSTEMS

AR15 DROP-IN SUPER SLIM HANDGUARDS

- MADE IN USA**
- 6061-T6 ALUMINUM**
- MIL-STD-1913 PICATINNY**
- DROP-IN**
- AVAILABLE COLOR(S)**
■ Matte Black Anodized

M-LOK® Drop-in Super Slim Rails:

- US PAT. D851199**
US PAT. D851200
- OCTAGONAL PROFILE**
- DIMENSION**

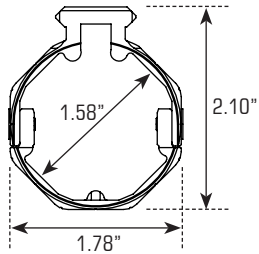

Drop-in Super Slim Rails:

- US PAT. D711492**
- TUBULAR PROFILE**
- DIMENSION**

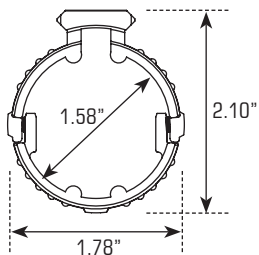

15" LENGTH
CARBINE LENGTH INSTALL



7" LENGTH
CARBINE LENGTH INSTALL



UTG PRO® AR15 Drop-In Super Slim Handguards

- Fits Carbine Length AR15 with Standard Barrel Nut/Delta Ring Assembly and Round Front Handguard Cap and Ruger AR556
- M-LOK® Drop-in Super Slim Handguards Include 2 M-LOK® Accessories, an 8 Slot Picatinny Rail Section and a QD Sling Swivel Adaptor
- Drop-in Super Slim Handguards Include 4 Rail Sections: Two 2 Slot and Two 4 Slot



Fits Carbine Length AR15 with Standard Barrel Nut / Delta Ring Assembly and Round Front Handguard Cap and Ruger AR556

Extended Drop-in Design with Cutout for Standard A2 Front Sight (MTU015SSM / MTU015SS Only)



15 INCH MTU015SSM
7 INCH MTU001SSM

M-Lok® Drop-In Super Slim Handguards



15 INCH MTU015SS
7 INCH MTU001SS

Drop-In Super Slim Handguards

Model #	MTU015SSM	MTU001SSM	MTU015SS	MTU001SS
Length	15.0"	7.3"	15.0"	7.3"
M-LOK® Slots	45	24	N/A	N/A
Top Picatinny Slots	31	18	32	18
Net Weight	12.4 oz	6.2 oz	14.1 oz	6.9 oz



Optional Accessories



RB-FGM01
Compact Polymer M-Lok® Foregrip
[Also Refer to P. 152]



RB-HP30M (4/PACK)
Low Profile M-Lok® Rail Panel Covers
[Also Refer to P. 157]



MT-FGM01X
Ultra Slim Foregrip
[Also Refer to P. 153]



MT-AFGM01
M-Lok® Angled Foregrip
[Also Refer to P. 150]







MT-FGM01
M-Lok® Super Slim Aluminum Vertical Foregrip
[Also Refer to P. 153]



TL-TRM01
M-Lok® Angled Index Mount
[Also Refer to P. 150]



AR15 DROP-IN QUAD RAIL HANDGUARDS

-  **MADE IN USA**
-  **6061-T6 ALUMINUM**
-  **PRECISION MACHINED**
-  **MIL-STD-1913 PICATINNY**
-  **AVAILABLE COLOR(S)**
■ Matte Black Anodized

UTG PRO® AR15 Drop-In Quad Rail Handguards

- Durable Finishes Provide Excellent Resistance to Corrosion and Wear
- Great Zero-retention for All Accessories Installed on Rails



MTU001

UTG PRO® AR15 Drop-In Carbine Length Quad Rail

- 2-piece Design with Alignment Housing for a Perfect Fit with the Standard Barrel Nut/Delta Ring Assembly and Round Front Handguard Cap



For Use with Round Front Handguard Cap



12 Pc. Rubber Rail Guards Included



MTU001T

UTG PRO® AR15 Drop-In Carbine Length Quad Rail with Continuous Top Rail

- Extended Top Rail Provides a Continuous Unimpeded Flat Top
- 2-piece Design with Alignment Housing for a Perfect Fit with the Standard Barrel Nut/Delta Ring Assembly and Round Front Handguard Cap



Extended Top Rail Provides a Continuous Unimpeded Flat Top



For Use with Round Front Handguard Cap



12 Pc. Rubber Rail Guards Included





MTU007

UTG PRO® AR15 Drop-In Mid-Length Quad Rail

- 2-piece Design with Integral Spinal Cords/Alignment Housing for Precise Fit
- Designed to be Compatible with Standard Triangular Front Handguard Cap



For Use with Triangular Front Handguard Cap



18 Pc. Rubber Rail Guards Included



MTU018

UTG PRO® AR308 Drop-In Mid Length Quad Rail

- Compatible with Smith & Wesson® M&P®10 and Clones



For Use with Round Front Handguard Cap



16 Pc. Rubber Rail Guards Included



MTU015

UTG PRO® AR15 Drop-In Carbine Length Quad Rail with Forward Extension

- 3-piece Design with Integral Spinal Cords/Alignment Housing for a Perfect Fit with the Standard Barrel Nut/Delta Ring Assembly and Round Front Handguard Cap
- Designed with Cutout to Accommodate Front Sight, Sling Swivel, and Bayonet Lug



For Use with Round Front Handguard Cap



18 Pc. Rubber Rail Guards Included



Model #	MTU001	MTU001T	MTU007	MTU018	MTU015
Length	6.7"	7.3"	8.7"	8.7"	10.7"
Top / Bottom / Left /Right Picatinny Slots	T:14 / B:14 / L:14 / R:14	T:18 / B:17 / L:16 / R:16	T:18 / B:18 / L:18 / R:18	T:19 / B:19 / L:19 / R:19	T:19 / B:22 / L:25 / R:25
Net Weight	11.3 oz	11.3 oz	14.7 oz	14.7 oz	17.1 oz



AR308 SUPER SLIM FREE FLOAT HANDGUARDS

MOUNTING SYSTEMS

AR308 SUPER SLIM FREE FLOAT HANDGUARDS

	MADE IN USA
	6061-T6 ALUMINUM
	PRECISION MACHINED
	MIL-STD-1913 PICATINNY
	OCTAGONAL PROFILE
	FREE FLOAT
	US PAT. 8806792
	AVAILABLE COLOR(S) ■ Matte Black Anodized
	PARTS INCLUDED



UTG PRO® AR308 Super Slim Free Float Handguards

- Proudly Designed and Made in the USA
- Precision Machined from 6061-T6 Aluminum and Finished in a Matte Black Hard Coat Anodization
- M-LOK® Slots on 7 slot Tracks for Mounting Accessories
- Lightening Cuts for Reduced Weight and Ergonomic Octagonal Profile with Grooved Surface
- Full Top Picatinny Rail is Flush and Continuous with Upper Receiver
- Integral Anti-rotation Tabs for Accurate Alignment with Upper Receiver and to Prevent Unintentional Handguard Rotation and Flex
- Includes M-LOK® Picatinny Rail Section and QD Sling Swivel Adaptor

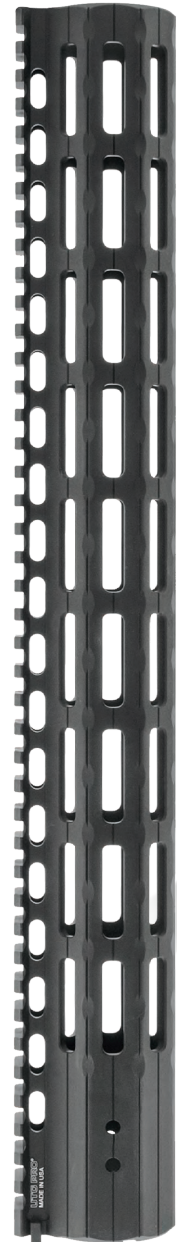

Scalloped Top Picatinny Rail Edges for Snag Free Accessories Mounting

Ergonomic Finger Grooves for a Solid and Comfortable Grip

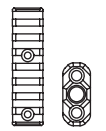

M-LOK® 8-Slot Picatinny Rail Section & QD Sling Swivel Adaptor

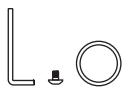

Installation Hardware



Barrel Nut and Locking Ring for A,B,C Models

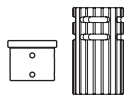

Barrel Nut and Locking Ring for E Model



Barrel Nut Wrench

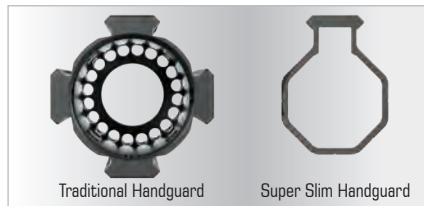

Super Slim Design for Comfort and Weight Reduction



Flush Fitting and Continuous with Upper Receiver

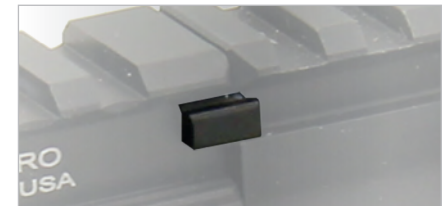

Integral Anti-rotation Tabs for Accurate Alignment with Upper Receiver

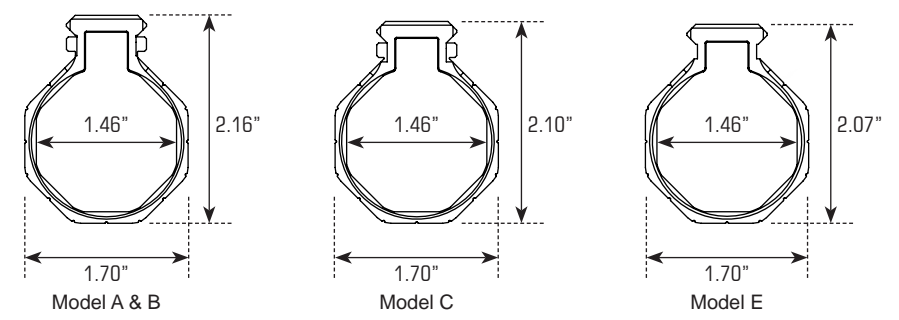

13 INCH MTU020SSMB
15 INCH MTU026SSMB
17 INCH MTU038SSMB

DPMS® LR-308 High Profile

15 INCH MTU026SSMC
17 INCH MTU038SSMC

S&W M&P®10 / DPMS® LR-308 Low Profile

13 INCH MTU020SSME
15 INCH MTU026SSME

DPMS® GII

15 INCH MTU026SSMA

ARMALITE® AR-10®

Model #	MTU020SSMB MTU020SSME	MTU026SSMA MTU026SSMB MTU026SSMC MTU026SSME	MTU038SSMB MTU038SSMC
Length	12.7"	15.1"	17.1"
M-LOK® Slots	42	56	63
Top Picatinny Slots	31	37	42
Net Weight	Model B -14.2 oz Model E -14.7 oz	Model A&B -15.8 oz Model C -15.5 oz Model E -16.3 oz	Model B -17.4 oz Model C -17.1 oz Model E -18.0 oz



OP3 MICRO REFLEX DOT SIGHT SUPER SLIM MOUNTS

6061-T6 ALUMINUM

PRECISION MACHINED

AVAILABLE COLOR(S)

Matte Black Anodized

RDM-2045 & RDM-20AC:

MIL-STD-1913 PICATINNY

RDM-20XSD, RDM-20GL, RDM-20SIG, & RDM-20SW:

REAR SIGHT DOVETAIL

RDM20

NEW

OP3 Micro Reflex Dot Sight Super Slim Mounts



Mounting Base Compatible with 9mm to 11mm Dovetail Dimensions (RDM-20XSD)



Utilizes Locking Torx Screws and Square-shaped Integral Recoil Stops for a Secure Zero Hold (RDM-2045 & RDM-20AC)



Utilizes Locking Torx Screws and Steel Dovetail Insert for a Secure Zero Hold (RDM-20GL, RDM-20SIG, and RDM-20SW)



OP3 Micro RDM-20XSD

Low Profile Dovetail Mount

OP3 Micro RDM-2045

45 Degree Angled Mount

OP3 Micro RDM-20AC

Absolute Co-Witness Mount

OP3 Micro RDM-20GL

Rear Sight Mount for Glock® Double Stack Rear Sight Mount

OP3 Micro RDM-20SIG

Rear Sight Mount for SIG P-Series Double Stack Rear Sight Mount

OP3 Micro RDM-20SW

Rear Sight Mount for S&W M&P® Double Stack Rear Sight Mount



RED DOT OP-RDM20R
GREEN DOT OP-RDM20G

OP3 Micro 4 MOA Single Dot

- 4 MOA Single Dot with 8 Power Intensity Settings
- 55,000+ Hours Battery Life for Red Illumination, 20,000+ Hours for Green Illumination at Middle Brightness Setting
- Magnetized Battery Compartment Prevents Intermittent Reticle Illumination and Flicker
- Larger 1" Wide Field of View Lens
- Optic Height Co-witnesses with Most Suppressor Height Iron Sights
- IPX7 Waterproof Rated
- Tertiary Aiming Point Laser Engraved on Rear Face of Optic Hood
- Low Profile Picatinny Mounting Base Included, Optic Base Uses Docter® Footprint
- 6061-T6 Aluminum Construction Finished in a Matte Black Anodization, Optic Cover Included

[Also Refer to P. 051]

Model #	RDM-20XSD	RDM-2045	RDM-20AC	RDM-20GL	RDM-20SIG	RDM-20SW
Length / Width	1.8" / 1.1"	1.8" / 2.5"	1.8" / 1.1"	1.8" / 1.1"	1.8" / 1.1"	1.8" / 1.1"
Saddle Height	0.3"	N/A	0.78"	0.15"	0.16"	0.16"
Weight	21.3 oz	1.5 oz	1.5 oz	0.5 oz	0.5 oz	0.5 oz



SUPER SLIM MOUNTS FOR RMR® | MRO® | T1

6061-T6 ALUMINUM

PRECISION MACHINED

AVAILABLE COLOR(S)

Matte Black Anodized

All Models (Excludes MT-RMRGL):

MIL-STD-1913 PICATINNY

MT-RMRGL:

REAR SIGHT DOVETAIL

RMR®



MT-RMR45

45 Degree Angled Mount for Trijicon RMR®



MT-RMR13C

Lower 1/3 Co-Witness Mount for Trijicon RMR®



MT-RMRAC

Absolute Co-Witness Mount for Trijicon RMR®



MT-RMRXS

Low Profile Mount for Trijicon RMR®



MT-RMRGL

Rear Sight Mount for Glock® Double Stack, Trijicon RMR®

MT-RMRKIT
2-In-1 Combo

Super Slim Mounts for RMR® | MRO® | T1

- Utilizes Locking Torx Screws and Square-shaped Integral Recoil Stops or Rear Sight Dovetail Insert for a Secure Zero Hold
- Significant Lightening Cuts Reduce Overall Weight and Bulk (Excludes Low Profile and Dovetail Models)



45 Degree Angled



Lower 1/3 Co-Witness



Absolute Co-Witness



Low Profile



Rear Sight Dovetail

T1



Additionally Compatible with Aimpoint® H1, H2, T2, and CompM5™



MT-T1AC

Absolute Co-Witness Mount for Aimpoint® T1



MT-T113C

Lower 1/3 Co-Witness Mount for Aimpoint® T1

MRO®



MT-MROAC

Absolute Co-Witness Mount for Trijicon MRO®



MT-MRO13C

Lower 1/3 Co-Witness Mount for Trijicon MRO®



MT-MROXS

Low Profile Mount for Trijicon MRO®

Model #	MT-RMR45	MT-RMR13C	MT-RMRKIT		MT-RMRGL	MT-T1AC	MT-T113C	MT-MROAC	MT-MRO13C	MT-MROXS
			MT-RMRAC	MT-RMRXS						
Length / Width	1.8" / 2.5"	1.8" / 1.1"	1.8" / 1.1"	1.8" / 1.1"	1.8" / 1.1"	1.9" / 1.2"	1.9" / 1.2"	1.5" / 1.2"	1.5" / 1.2"	1.5" / 1.2"
Saddle Height	N/A	0.95"	0.87"	0.40"	0.16"	0.78"	1.05"	0.65"	0.76"	0.20"
Weight	1.4 oz	1.6 oz	1.5 oz	1.4 oz	0.4 oz	1.3 oz	1.3 oz	0.9 oz	0.9 oz	0.6 oz



UNIVERSAL SUPER SLIM RISER MOUNTS

- 6061-T6 ALUMINUM
- PRECISION MACHINED
- MIL-STD-1913 PICATINNY
- AVAILABLE COLOR(S)
- Matte Black Anodized

MT-RSX5S & MT-RSX5L:

US PAT. D784482

DIMENSION

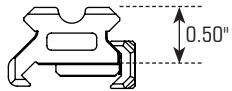

MT-RSX7S & MT-RSX7L:

US PAT. D784483

DIMENSION

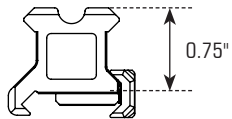

MT-RSX8S & MT-RSX8L:

DIMENSION

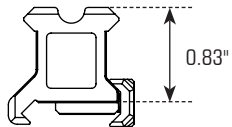

MT-RSX1S & MT-RSX1L:

US PAT. D784481

DIMENSION

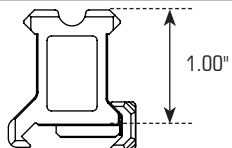

Universal Super Slim Riser Mounts

- Significant Lightening Cuts Reduce Overall Weight and Bulk (Medium and High Profile Only)



- 0.50" MT-RSX5S
- 0.75" MT-RSX7S
- 0.83" MT-RSX8S
- 1.00" MT-RSX1S

3 Slot



- 0.50" MT-RSX5L
- 0.75" MT-RSX7L
- 0.83" MT-RSX8L
- 1.00" MT-RSX1L

13 Slot



MT-RSX20MOA
13 Slot / 20 MOA
Elevated Compensation

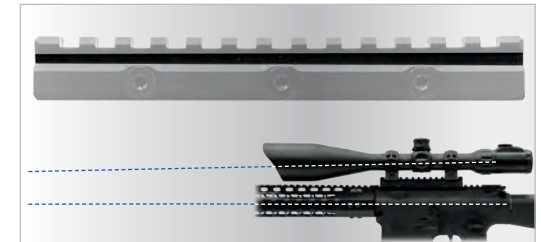

20MOA Compensation Maximizes Optic Elevation Adjustment for Zeroing at Long Range Distances

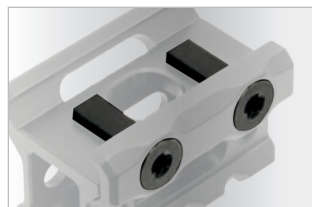

Utilizes Locking Torx Screws and Square-shaped Integral Recoil Stops for a Secure Zero Hold



Rail Slots Index Perfectly with Handguard or Flat Top Slots

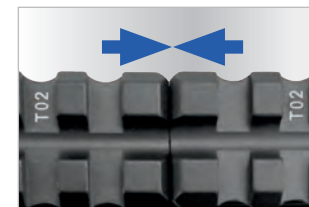

Multiple Riser Mounts Form One Continuous Picatinny Rail (Excludes MT-RSX20MOA)

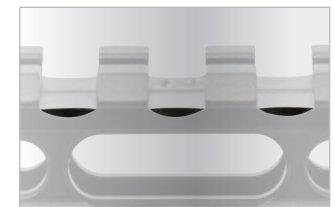

Scalloped Picatinny Slots for Snag Free Accessory Mounting

Model #	MT-RSX5S	MT-RSX7S	MT-RSX8S	MT-RSX1S	MT-RSX5L	MT-RSX7L	MT-RSX8L	MT-RSX1L	MT-RSX20MOA
Length	1.6"	1.6"	1.6"	1.6"	5.5"	5.5"	5.5"	5.5"	5.5"
Saddle Height	0.50"	0.75"	0.83"	1.00"	0.50"	0.75"	0.83"	1.00"	N/A
Picatinny Slots	3	3	3	3	13	13	13	13	13
Weight	0.9 oz	0.9 oz	1.0 oz	1.0 oz	2.7 oz	2.7 oz	2.8 oz	2.8 oz	2.7 oz



UNIVERSAL ANGLED | RISER MOUNTS

M-LOK® Angled Picatinny Mount

- Angled Offset Optimally Positions Lights, Optics, or Other Accessories at the 11 or 1 O'clock Positions on Most Handguards
- Durable Matte Black Anodized Aluminum Construction
- Dehorned Corners, Scalloped Slots, and Melted Contours Reduce Snagging



NEW

MT-MP45
3 Slot / M-LOK®

Universal Riser Mounts

- Precision Machined from Aircraft Aluminum with a Matte Black Finish
- Universal Riser Mount Fits All Picatinny Rails



0.60" MNT-RSQD403
3 Slot / QD Lever Lock

US PAT. 8397421

0.60" MNT-RSQD605
5 Slot / QD Lever Lock



0.83" MNT-RS08S3
1.00" MNT-RS10S3
3 Slot / Twist Lock



QD Lever Lock



Twist Lock



Laser Application



Foregrip Application



Optic Application



Model #	MT-MP45	MNT-RSQD403	MNT-RSQD605	MNT-RS08S3	MNT-RS10S3
Length	1.6"	1.6"	2.4"	1.6"	1.6"
Saddle Height	1.31"	0.60"	0.60"	0.83"	1.00"
Locking Method	M-LOK®	QD Lever Lock	QD Lever Lock	Twist Lock	Twist Lock
Picatinny Slots	3	3	5	3	3
Weight	0.9 oz	2.3 oz	3.0 oz	1.9 oz	1.7 oz



AK HANDGUARDS & MOUNTS

MOUNTING SYSTEMS

AK HANDGUARDS & MOUNTS

- MADE IN USA**
- 6061-T6 ALUMINUM**
- PRECISION MACHINED**
- MIL-STD-1913 PICATINNY**
- OCTAGONAL PROFILE**
- 922R COMPLIANT**
- PAT. PENDING**
- AVAILABLE COLOR(S)**

■ Matte Black Anodized

MTU053SSM: PARTS INCLUDED

- Docter® Footprint Adapter Plate**
- M-LOK® 9-Slot Detachable Picatinny Rail Section**
- Installation Hardware**

MTU009SSK: PARTS INCLUDED

- 4-Slot Picatinny Rail Section**
- Receiver Bridge Mount**
- Installation Hardware**



UTG PRO® Super Slim M-LOK® AK Handguard

- Proudly Designed and Made in USA
- Two-piece Drop-in Design Requires No Permanent Modification
- Modular Top End Mounts Included 9 Slot Picatinny Rail Section or Docter® Footprint MRDS Plate for Optics Installation
- Compatible with Most Romanian, Chinese, and US AK Pattern Rifles
- Durable Matte Black Anodized 6061-T6 Aluminum Construction
- Total of 15 M-LOK® Slots

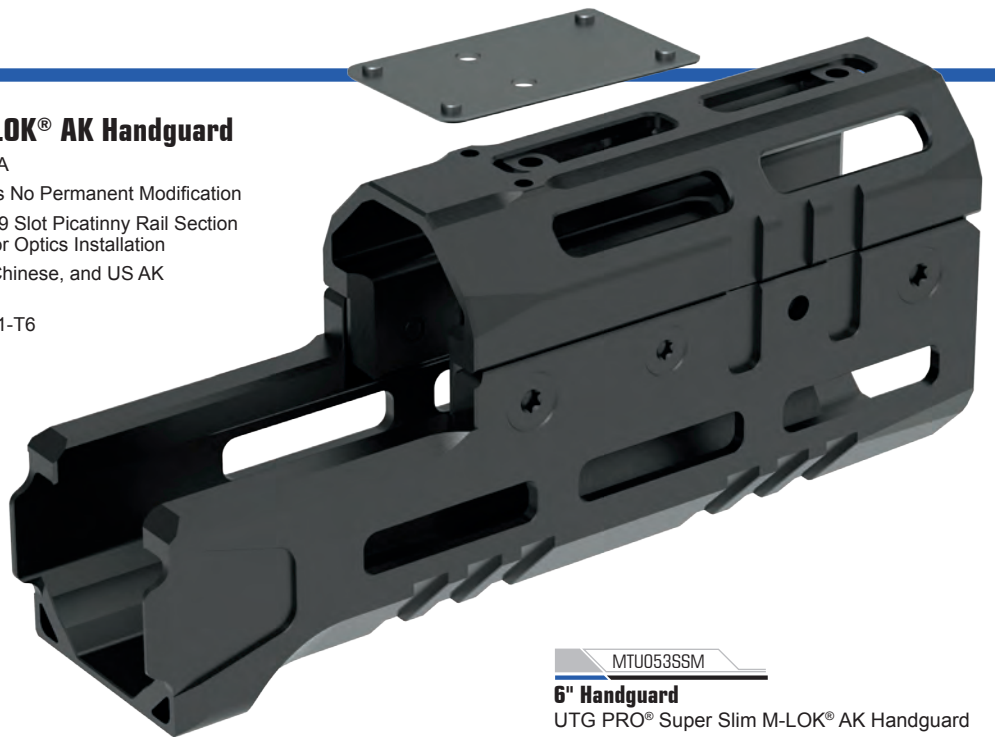
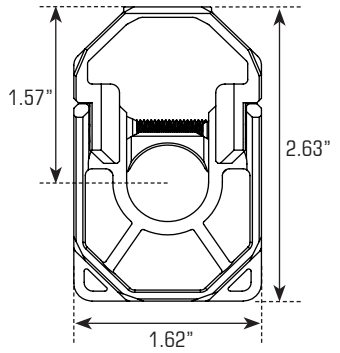

MTU053SSM
6" Handguard
UTG PRO® Super Slim M-LOK® AK Handguard





UTG PRO® AK Super Slim Keymod Handguards



- Top and Bottom 2-piece Design with Internal Locking Screw Placement
- Ergonomic Octagonal Profile with Grooved Surface for a Solid Grip
- Compatible with Romanian, Bulgarian, and Chinese AKs or Clones



Ergonomic Finger Grooves for a Solid and Comfortable Grip

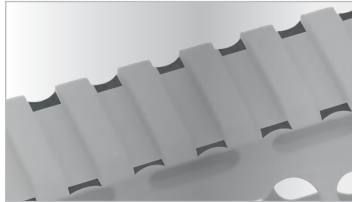

Scalloped Top Picatinny Rail Edges for Snag Free Accessory Mounting

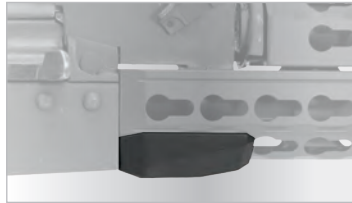

Receiver Bridge Mount for Smooth Interface with AK Receiver



MTU009SSK
6" Handguard

Scalloped Top Picatinny Rail Edges for Snag Free Accessory Mounting

Ergonomic Finger Grooves for a Solid and Comfortable Grip

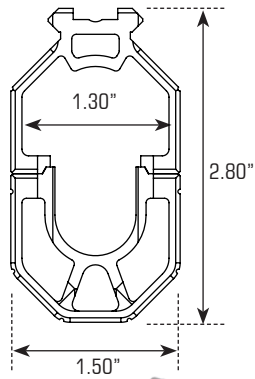

Deep U-cut Channel for Accessing Iron Sights



2 Side M-LOK® Slots for Attaching Accessories

NEW

MT-ZAK01

UTG® QD AK Side Mount, Zastava M70 Series

- Designed Specifically for the Zastava M70 Series
- Matte Black Anodized 6061-T6 Aluminum Construction
- Adjustable Quick-detach Lever Mount
- Scalloped 15 Slot Picatinny Rail Features a Deep U-cut Channel for Accessing Iron Sights
- Overall Lightweight Design Features 2 Side M-LOK® Slots for Attaching Accessories

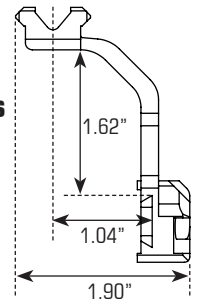

MOUNTING SYSTEMS

AK HANDGUARDS & MOUNTS

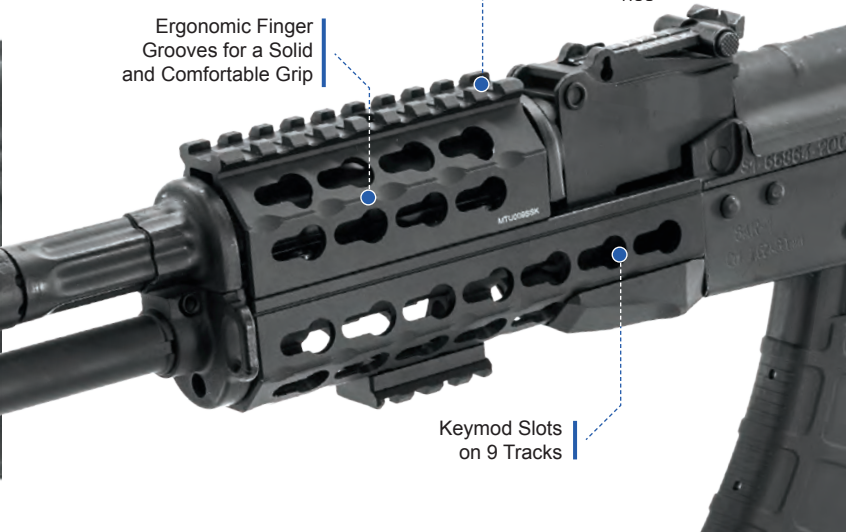

Keymod Slots on 9 Tracks

Model #	MTU053SSM	MT-ZAK01	MTU009SSK
Length	6.05"	6.69"	6.0"
M-LOK® / Keymod Slots	15 M-LOK®	2 M-LOK®	51 Keymod
Top Picatinny Slots	9, Detachable	16	9
Net Weight	9.7 oz	5.3 oz	5.1 oz
Compatible	Most Romanian, Chinese, and US AKs	Zasava M70 Z PAP, N-PAP and O-PAP	Most Romanian, Chinese, and US AKs



AK QUAD RAIL HANDGUARDS

MOUNTING SYSTEMS

AK QUAD RAIL HANDGUARDS



MTU052

UTG PRO® M92 QUAD RAIL HANDGUARD

- CNC Machined from 6061-T6 Aluminum and Finished in a Matte Black Anodization
- Lightening Cut Quad Rail with Integral QD Sling Swivel Housings on the Left and Right Hand Side
- Drop-in Installation, Requires No Permanent Modification
- 13 Scalloped Picatinny Slots on the 3, 6, and 9 O'clock Rails with 9 Slots on the 12 O'clock
- Rail Edges are Chamfered with its Corners Dehorned
- Designed Specifically for the Zastava M92



X 11

11 Pc. Rubber Rail Guards Included

MTU009

UTG PRO® Romanian/Chinese/US AK Quad Rail Handguard

- Universal Design Fits Romanian, Bulgarian, Chinese, and US AKs or Clones Including Those with an Oversized Barrel and Rear Sight Block



X 12

12 Pc. Rubber Rail Guards Included



MTU010

UTG PRO® AMD-65 Quad Rail Handguard

- Fits Hungarian AMD-65 and Clones



X 12

12 Pc. Rubber Rail Guards Included



MTU011

UTG PRO® YUGO AK Quad Rail Handguard

- Fits Yugo AKs and Clones
- Also Compatible with Zastava N-PAP Series After Removal of Rear Handguard Retainer



X 11

11 Pc. Rubber Rail Guards Included



Model #	MTU052	MTU009	MTU010	MTU011
Length / Width	6.5" / 2.1"	8.4" / 2.1"	8.4" / 2.1"	6.5" / 2.1"
Top / Bottom / Left /Right Picatinny Slots	9/15/15/15	T:14 / B:14 / L:14 / R:14	T:15 / B:14 / L:14 / R:14	T: 9 / B:15 / L:15 / R:15
Net Weight	9.5 oz	9.2 oz	9.2 oz	9.5 oz



AK RECEIVER MOUNTS



MTU016

UTG PRO® AK Quick Detach Side Mount

- Precision Machined from 6061-T6 Aircraft Aluminum with a Matte Black Anodization
- Lightweight Design with U-cut Channel Top Rail for Reduced Weight
- Equipped with a 16 Slot Picatinny Top Rail and Detachable 6 Slot Side Rail
- Fits Most AKs and Clones with Side Optic Rail



U-cut Channel



TL-M47SR

UTG® AK Steel Side Plate

- Durable Steel Construction with a Matte Black Finish
- Fits Both Milled and Stamped AK Receivers and Accepts a Wide Variety of Side Optic Mounts
- Permanent Modification Required



MTU014

UTG PRO® AK QD Low Profile Top Rail System

- Low Profile 19 Slot Picatinny Top Rail
- Fits Romanian, Chinese, and US AKs or Clones, as well as, Saigas Equipped with Rear Sight Blade and Fixed Butt Stock
- **NOTE:** Does Not Work with Milled Receivers with a Slanted Tang



Precision Machined from 6061-T6 Aircraft Aluminum with a Matte Black Anodization



Quick Detachable for Ease of Disassembly and Maintenance

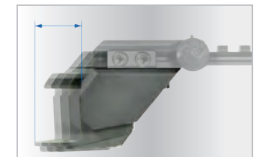

Adjustable Rear Block for Installation on Different AKs or Clones



Low Profile Design



Complete with Back-up Windage-adjustable Rear Sight

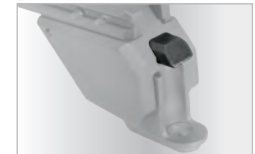

Convenient and Reliable Lock/Release Push Button



SKS | MOSIN NAGANT MOUNTS

922R COMPLIANT



MTU017

UTG PRO® SKS Receiver Cover with Integrated Picatinny Rail and Shell Deflector

- Precision Cast and Machined High-strength Steel Base
- Top Rail Precision Machined from 6061-T6 Aircraft Aluminum with a Matte Black Anodization
- Full Length 22 Slot Top Picatinny Rail
- Precise and Repeatable 4 Point Locking Engagement of Receiver



U-cut Channel



MNT-MNTR01

Mosin Nagant Tri-rail Mount

- Steel Base with Adaptors to Fit the Rear Sight Housing of Full or Carbine Length Rifles
- Tri-rail Made from Aircraft Aluminum with a Matte Black Finish
- Extended Top Rail with 17 Slots to Provide Ample Space for Eye Relief Adjustment
- Removable 12 Slot Side Rails



X4

4 Pc. Rubber Rail Guards Included





SHOTGUN MOUNTS



MTU029SG



UTG PRO® Optic Mount for Mossberg® 500®

MNT-MB500T • Overseas Production

- The Michigan Difference - Enhanced Precision, Material Strength, and Quality Control
- Compatible with Drilled and Tapped Mossberg® Shotguns
- **NOTE:** The Screws Included are for 500s Made After 1998. For Earlier Versions, Please Contact Leapers for Appropriate Screws



MTU028SG



UTG PRO® Optic Mount for Remington® 870™

- Precision Machined from Aircraft Aluminum with a Matte Back Anodized Finish
- Fits Drilled and Tapped Remington® Model 870™ / 1100 Shotguns and Clones



MT-RM870

UTG® Optic Mount for Remington® 870™

- Durable 6061-T6 Aluminum Construction Finished in a Matte Black Anodization
- Removable 4-Capacity Shot Shell Carrier Included
- Full Length Picatinny Top Rail for Ample Optic Real Estate
- Compatible with 12 Gauge Remington® 870™ and 870 DM Shotguns with up to a 3.5" Chambering
- No Permanent Modification Required



Shot Shell Carrier Included



MT-MB590

MT-MB590M

UTG® Optic Mount for Mossberg® 590®/ 590M®

- Durable 6061-T6 Aluminum Construction Finished in a Matte Black Anodization
- Removable 4-Capacity Shot Shell Carrier Included
- Full Length Picatinny Top Rail for Ample Optic Real Estate
- Compatible with 12 Gauge Mossberg® 500®/590® Shotguns (MT-MB590) and 590M® Mag-Fed Shotguns (MT-MB590M)
- No Permanent Modification Required



Shot Shell Carrier Included

Model #	MTU029SG	MNT-MB500T	MTU028SG	MT-MB590	MT-MB590M	MT-RM870
Length / Width	5.5" / 0.4"	5.5" / 0.4"	6.1" / 0.8"	7.0" / 1.8"	7.6" / 1.8"	7.3" / 2.1"
Top Picatinny Slots	13	13	14	13	12	14
Net Weight	1.2 oz	1.4 oz	1.6 oz	4.2 oz	4.4 oz	7.0 oz



BOLT ACTION MOUNTS FOR M1A® | M1 | 10/22®



MNT-914V2

Scope Mount for M14®/M1A™

- Precision Machined from Aircraft Aluminum with a Matte Black Finish
- 6" Length with 15 Picatinny Top Slots
- 4-Point Locking System Interfaces with the Stripper Clip Guide and Three Different Points of the Receiver Providing a Rock Solid Foundation



MNT-M1C

M1 Carbine Mount Complete With 1" Rings

- Precision Machined from Aircraft Aluminum with a Matte Black Finish



MNT-R22SS26

Scout Rail for Ruger® 10/22® Rifles

- 11.7" Length with 26 Picatinny Top Slots
- Lightening Cuts for Weight Reduction
- Free Float Rail Does not Touch Barrel or Forend
- Compatible with Drilled and Tapped 10/22® Receivers



MTU030T22

MNT-22TOWL
• Overseas Production



MTU030T22

UTG PRO® Low Profile Scope Mount For Ruger® 10/22® Rifles

- Precision Machined from Aircraft Aluminum with a Matte Black Anodized Finish
- 4.67" Length with 11 Picatinny Slots
- Compatible with Drilled and Tapped Receivers



MNT-RM700

Scope Mount for Remington® 700® Long Action Rifles

- Solid Steel Construction
- 6.3" Length with 6 Picatinny Top Slots
- Clearance Cut for Reliable Case Ejection



MNT-RM700S

Scope Mount for Remington® 700® Short Action Rifles

- Solid Steel Construction
- 5.47" Length with 6 Picatinny Top Slots
- Clearance Cut for Reliable Case Ejection





MOUNTS FOR MP5 | G3 | G36



MNT-P669

MP5 | G3 Low Profile Claw Mount

- Low Profile Top Rail with 13 Picatinny Slots
- Precision Machined from Aircraft Aluminum with a Matte Black Finish

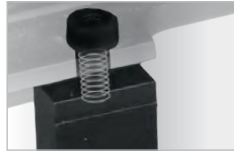

Spring-Tensioned Claws and Receiver Set Screws for a Solid Installation



MNT-HK02

MP5 | G3 Steel Claw Mount

- Complete with Detachable Steel Top Picatinny Rail and Secondary STANAG Mounting Base

STANAG Compatible



MNT-G3601

G36 | SL8 Carry Handle Scope Mount

- Precision CNC Machined from Aircraft Aluminum with a Matte Black Finish
- 11.45" Length with 27 Picatinny Slots
- Lightweight and Low Profile, Securely Fits Into Standard G36/SL8 Carry Handle



G36 Picatinny Rail Sets

- Laser Engraved for Left, Right, and Bottom Designation and Accessory Placement



MNT-P503

Set of 3

- One 6.08" Length Rail with 13 Picatinny Slots and Two 3.87" Length Rails with 7 Picatinny Slots



MNT-P505

Set of 3

- Three 6.08" Length Rails with 13 Picatinny Slots



MNT-P501

Set of 2

- Two 3.87" Length Rails with 7 Picatinny Slots





UNIVERSAL RIFLE | SHOTGUN BARREL MOUNTS

MOUNTING SYSTEMS

UNIVERSAL RIFLE | SHOTGUN BARREL MOUNTS

Universal Rifle Barrel Mounts

- Precision Machined from Aircraft Aluminum with a Matte Black Finish
- Compatible Firearm Barrel Range: Diameter \varnothing .51" - .78"



MNT-BR002S
Single-Rail / 2 Slot



MNT-BR005S
Single-Rail / 5 Slot

Universal Shotgun Barrel Mounts

- Precision Machined from Aircraft Aluminum with a Matte Black Finish
- Compatible Firearm Barrel Range: Diameter \varnothing .75"-.1.10"



MNT-BR003XLS
Single-Rail / 3 Slot



Universal Rifle Application



Universal Shotgun Application

Model #	MNT-BR002S	MNT-BR005S	MNT-BR003XLS
Length / Width	1.2" / 1.4"	2.4" / 1.4"	1.6" / 1.7"
Top / Bottom / Left / Right Picatinny Slots	B: 2	B: 5	B: 3
Compatible Barrel Diameter	\varnothing .51"-.78"	\varnothing .51"-.78"	\varnothing .75"-.1.10"
Compatible Flashlight/Laser Diameter	N/A	N/A	N/A
Net Weight	1.2 oz	2.0 oz	1.8 oz



US PAT. 10352656
 EU PAT. EP3196588

MNT-DTW145
Universal Dovetail To Picatinny Rail Adaptor

- Precision Machined from Aircraft Aluminum with a Matte Black Finish
- Compatible with 9mm-11mm Dovetail Rails



US PAT. D837330



Optimized Interface to Fit Undersized, Standard, and Oversized Rounded and Flat Receivers

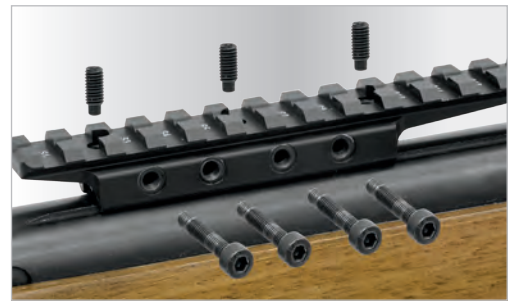

Repeatable Zero Hold and Bidirectional Recoil Resistance

MNT-PMTOWL-A
Dovetail to Picatinny Adaptor Mount

- Precision Machined from Aircraft Aluminum with a Matte Black Finish
- 3.94" Scalloped 9 Slot Picatinny Rail with 0.59" Saddle Height
- Compatible with Flat Receivers Equipped with 9mm-11mm Dovetail Rails



BARREL DROOP COMPENSATING

MNT-DNT06
Compensation Mount for T06 Trigger Equipped RWS Diana Air Rifles

- Precision Machined from Aircraft Aluminum with a Matte Black Finish
- Compensation to Bring the POI (Point Of Impact) Up 10 Inches at 30 Yards

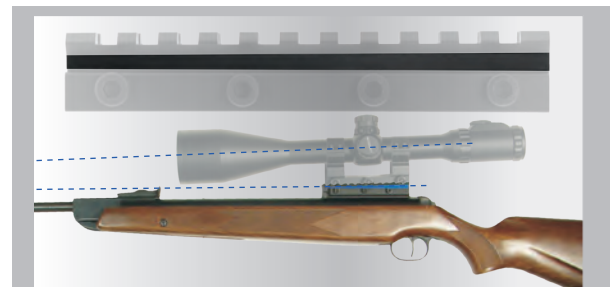

What's Barrel Droop ?



Barrel droop means that the barrel's bore is pointing downward in relation to the plane of the scope base. Compensating meant cranking up the elevation knob to bring the pellet back up to where the crosshairs are at or inserting a shim. UTG's compensation mount takes care of this for you, and is designed with special slopes to compensate for the barrel droop of RWS Diana air rifles.



US PAT. 8752325

MNT-DT2PW01 (Set of 2)
Dovetail-To-Picatinny Snap-in Rail Adaptor

- Allows Most Picatinny Products to Fit Dovetail Rails
- Spring Tensioned Design Snaps Adaptor into Picatinny/Weaver Base
- Features Removable Stop Pin for Added Retention

Model #	MNT-DTW145	MNT-PMTOWL-A	MNT-DNT06
Length / Width	5.7" / 0.8"	3.9" / 0.9"	4.7" / 1.0"
Slope	N/A	N/A	1.1/120
Upward at 30 Yds	N/A	N/A	10"
Top Picatinny Slots	14	9	11
Net Weight	2.4 oz	2.2 oz	3.8 oz