



U n l e a s h T h e G l o w



NEW GEN

U n l e a s h T h e G l o w

**OWNER'S  
MANUAL**

LT-EL268-A

LT-EL228Q-A





# CAUTION!

If you need to mount the flashlight onto a firearm, make sure firearm is not loaded before installation. Remove magazine and examine chamber. Use safe handling procedures at all times.

Tactical flashlights produce substantial heat during operation. Do not leave activated flashlight unattended. Do not set activated flashlight face down. Do not place activated flashlight against combustible material or material that could be damaged by heat. Do not hold bezel or lens of activated flashlight against any portion of human body. Keep away from children.

Ensure that the flashlight cannot be turned on when stored or being transported. If the lamp is activated while in a case or any container, the lamp could overheat and cause damage to surrounding materials.

Examine battery quality and appearance before use each time and make sure that there is no leaking or any deformation. Dispose appropriately if there is a problem.

The batteries are pre-charged by the manufacturer, and cannot be recharged. Recharging can cause battery leakage or, in some cases, high-pressure rupture. Inadvertent charging can occur if a battery is installed backwards.

Do not use re-chargeable batteries in the light. Only non-rechargeable batteries should be used with the light.

Install batteries by aligning the + and – signs marked on the battery with the + and – signs marked on the battery chamber in the light.

Turn off the light when not in use to conserve battery power.

Make sure to turn off the light or disconnect the pressure switch before inspecting bulb and battery if the light cannot be turned on.

Keep batteries cool and dry. Always remove batteries from light after use. Leaving battery in the light without use for long period of time may cause damage or danger.

Always replace batteries with the exact type and size specified for the light.

Always replace the whole set of batteries at the same time. Never mix new and used batteries in the same light.

Never deliberately short circuit batteries. Prolonged short circuit will cause the battery to lose energy and result in significant temperature increase.

Keep battery compartment clean and keep any metallic object away from the battery.

Lithium batteries can explode or cause burns if disassembled, shorted, recharged, exposed to water, fire, or high temperatures. Do not place loose batteries in a pocket, purse, or other container containing metal objects. Do not mix new with used batteries or mix required batteries with other types of battery. Do not store batteries with hazardous or combustible materials. Store in cool, dry, ventilated area. Follow applicable laws and regulations for disposal.

# Component Illustration

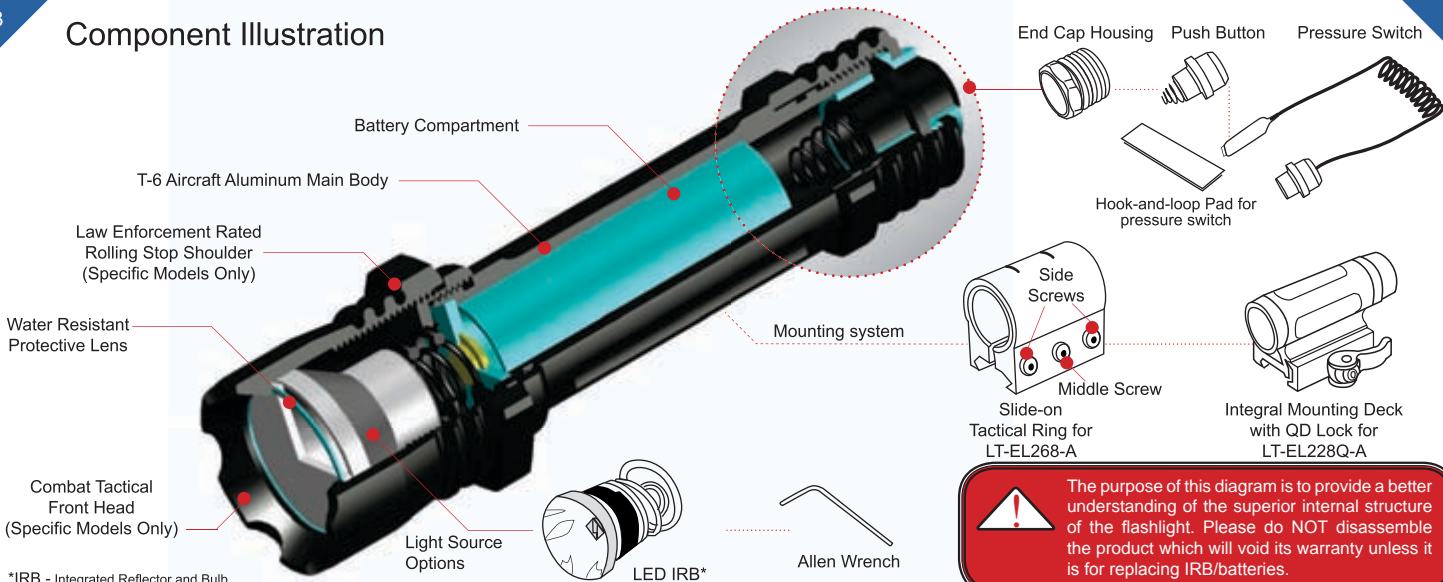

Battery Compartment

T-6 Aircraft Aluminum Main Body

Law Enforcement Rated Rolling Stop Shoulder (Specific Models Only)

Water Resistant Protective Lens

Combat Tactical Front Head (Specific Models Only)

\*IRB - Integrated Reflector and Bulb

Light Source Options

LED IRB\*

Mounting system

End Cap Housing Push Button Pressure Switch

Hook-and-loop Pad for pressure switch

Side Screws

Middle Screw

Slide-on Tactical Ring for LT-EL268-A

Integral Mounting Deck with QD Lock for LT-EL228Q-A

Allen Wrench

 The purpose of this diagram is to provide a better understanding of the superior internal structure of the flashlight. Please do NOT disassemble the product which will void its warranty unless it is for replacing IRB/batteries.

LT-EL268-A		
Specs	Length	134.5mm (5.29")
	Main Body Diameter	25.4mm (1")
	Weight with Battery	164.4g (5.8oz)
	Bulb Type	26.5 mm LED IRB* with Cree XML LED
	Voltage	6V
	Max. Output	400 lumens <b>NEW</b>
	Focus	Preset Flood
	Battery Operating Time	3 hrs+ <b>NEW</b>
Accessory	Battery/Qty	CR123A x 2
	Pressure Switch	Included
	Mount/Ring	Slide-on Tactical Ring

\*IRB - Integrated Reflector and Bulb

LT-EL228Q-A		
Specs	Length	138mm (5.42")
	Main Body Diameter	27mm (1.07")
	Weight with Battery	185g (7oz)
	Bulb Type	26.5 mm LED IRB* with Cree XML LED
	Voltage	6V
	Max. Output	400 lumens <b>NEW</b>
	Focus	Preset Flood
	Battery Operating Time	3 hrs+ <b>NEW</b>
Accessory	Battery/Qty	CR123A x 2
	Pressure Switch	Included
	Mount/Ring	Integral QD Mounting Deck

\*IRB - Integrated Reflector and Bulb

# Installation & Operation

## Battery Installation

1. Unscrew the end cap and install a CR123A lithium battery (Fig.1.1).
2. Replace and tighten the end cap (Fig.1.2).

## Three Operation Modes

1. End Cap with Push Button Twist-on
  - 1). Tighten the End Cap until the light is on (Fig.2.1).
2. End Cap with Push Button Momentary Push-On
  - 1). Tighten the End Cap until the light is on (Fig.2.1).
  - 2). Slightly loosen the End Cap until the light is off (Fig.2.2).
  - 3). Press and hold the Push Button in the center to turn on the light. Release the Push Button to turn off the light (Fig.2.3).
  - 4). Repeat step 1) and 2) to find the best press/hold/release tension.
3. Pressure Switch Operation
  - 1). Separate the Push Button and the End Cap housing from the Main Body. Separate the Push Button and the End Cap housing (Fig.2.4).
  - 2). Replace the Push Button with the Pressure Switch (Fig.2.5).
  - 3). Screw the end cap from the Pressure Switch onto the light and tighten snugly (Fig.2.6).
  - 4). Depress the Press Pad of the switch to turn on the light and release to turn off (Fig.2.7).

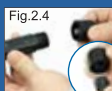
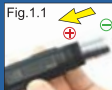

## Mounting the Flashlight

1. Slide-on Tactical Ring (For LT-EL268-A)
  - 1). Remove the End Cap from the flashlight and Slide the ring onto the flashlight (Fig.3.1).
  - 2). Replace and tighten the end cap (Fig.3.2).
  - 3). Slide the ring to the mount rail of the rifle or other application. Tighten the Side Screws on the ring to ensure a firm grip on the rail (Fig.3.3).
  - 4). Tighten the Middle Screw to firmly secure the flashlight (Fig.3.4). **Recommended torque value: 20-inch-lb.**



Do not over tighten the screws as you could cause damage to the flashlight body.

2. Integral QD Mounting Deck (For LT-EL228Q-A)
  - 1). Turn the Cam Lever leftward to its unlocked position. Seat the crossbar into a selected slot (Fig.4.1).
  - 2). Turn the Cam Lever to begin locking. Do not complete the locking motion to allow for adjustment (Fig.4.2).
  - 3). Use included Allen wrench to adjust the hex screw for proper tension and fit against the rail (Fig.4.3).
  - 4). Once the optimal tension is achieved, push the Cam Lever all the way. You may repeat step 3) and 4) if needed to find the best clamping tension (Fig.4.4).

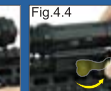
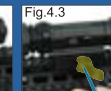
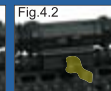
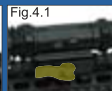

## LT-EL228Q-A Mounting System Illustration

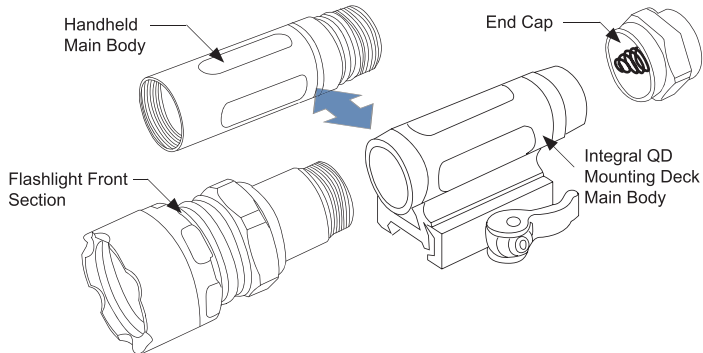

LT-EL228Q-A can be used as a handheld flashlight or a weapon-mount flashlight.  
To exchange:

Unscrew the flashlight End Cap and set it aside.  
Remove the batteries from the battery compartment.  
Separate the main body (either Handheld Main Body or Integral Mounting Deck Main Body) from the Front Section. Replace with the other style Main Body.  
Replace the batteries and End Cap.

## IRB\* Replacement



1. Make sure there is no battery in the light. Unscrew the Front Head counterclockwise to expose the bulb.
2. Pull out IRB\* from the Flashlight Head.
3. Follow the above steps in reverse order to install a new IRB\*.



\*IRB - Integrated Reflector and Bulb



Make sure the flashlight is totally cool down before replacing right bulb.

## Replacement Parts

Contact your distributor for information:

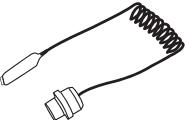
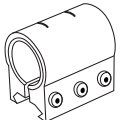
	
Lithium Battery	LED IRB*
2PC of CR123A Lithium Battery	26.5mm IRB* with Cree XML LED
	
TL-PSTL099-A	RG-FL860
Pressure Switch	UTG Slide-on Tactical Ring

\*IRB - Integrated Reflector and Bulb

## Maintenance

1. Maintain the metal surface of the flashlight by removing any dirt or sand with a soft brush to avoid scratching the finish.
2. Store the flashlight in a cool dry place when not in use. Be careful to avoid contact with acid, alkaline or corrosive chemicals.
3. Replace the batteries in your flashlight every few months if it was not used for a long period of time. This insures good working batteries for your light and prevents battery leakage.
4. Keep a fresh package of batteries next to your flashlight. This gives you back-up power for your light.
5. Do not store your flashlight in high temperatures. This may damage your flashlight or result in battery leakage.
6. When turned on, do not put the flashlight head against any surface, especially paper-like material or human skin, accidents or burns may occur after prolonged use.
7. Do not leave your flashlight under the seat of your car or in direct sunlight to avoid over-heating issues.
8. Do not attempt to lubricate any part of the flashlight.
9. Do not disassemble the flashlight outside of replacing the batteries, bulb, or the different types of activation end caps. Any such or similar actions will void warranty.

## One Year Limited Warranty

This warranty covers defects in materials and workmanship of the product, provided that they are purchased from an authorized distributor and purchased and used in the United States. The warranty lasts for a period of one year from the date of original purchase of the product.

You are entitled to rights under this warranty only if you are the original purchaser of the product and have the original purchase receipt. This warranty is not transferable. We will at our option, repair or replace products that do not conform to this warranty. We may use functionally equivalent reconditioned, refurbished, remanufactured, pre-owned or new products or parts.

This warranty is void if:

- the product has been disassembled, tampered with or parts or screws have been removed or loosened; or
- the product has been abused, maliciously damaged, mistreated or used for a purpose contrary to the purpose for which it was designed or the instructions provided with the product.

For Warranty service, please contact your authorized distributor and provide them with a written description of the defect and your original purchase receipt. You must obtain a Return Authorization Number and return procedures with delivery destination before returning the product for repair or replacement.

## Disclaimer and Limitation of Liability

Leapers is pleased to offer suggestions of the use of its products, however Leapers neither assumes responsibility for any omissions or errors nor assumes liability for any damages that result from the use of its products in accordance with information provided by Leapers, whether verbal or written.

EXCEPT FOR THE EXPRESS WRITTEN WARRANTY SPECIFICALLY SET FORTH ABOVE, ALL EXPRESS AND IMPLIED REPRESENTATIONS AND WARRANTIES ARE HEREBY DISCLAIMED, INCLUDING ANY IMPLIED WARRANTY OF MERCHANTABILITY, NON-INTERFERENCE, FITNESS FOR A PARTICULAR PURPOSE, NON-INFRINGEMENT, OR WARRANTY OF ACCURACY OF ANY INFORMATION PROVIDED WHETHER WRITTEN OR ORAL. ALL WARRANTIES ARISING FROM ANY COURSE OF DEALING, LAW, USAGE OR TRADE PRACTICE ARE HEREBY EXPRESSLY EXCLUDED TO THE EXTENT ALLOWED BY LAW. TO THE EXTENT AN IMPLIED WARRANTY CANNOT BE EXCLUDED, SUCH WARRANTY IS LIMITED IN DURATION TO ONE YEAR. SOME STATES OR JURISDICTIONS DO NOT ALLOW LIMITATIONS ON HOW LONG AN IMPLIED WARRANTY LASTS, SO THE ABOVE LIMITATION MAY NOT APPLY TO YOU.

UNDER NO CIRCUMSTANCES IS LEAPERS, OR ITS SUPPLIERS OR RESELLERS LIABLE FOR ANY OF THE FOLLOWING EVEN IF INFORMED OF THEIR POSSIBILITY: 1) THIRD PARTY CLAIMS AGAINST YOU FOR DAMAGES; 2) SPECIAL, INCIDENTAL, OR INDIRECT DAMAGES OR FOR ANY ECONOMIC CONSEQUENTIAL DAMAGES; OR 3) LOST PROFITS, BUSINESS REVENUE, GOODWILL, OR ANTICIPATED SAVINGS. SOME STATES OR JURISDICTIONS DO NOT ALLOW THE EXCLUSION OR LIMITATION OF INCIDENTAL OR CONSEQUENTIAL DAMAGES, SO THE ABOVE LIMITATION OR EXCLUSION MAY NOT APPLY TO YOU.