



U n l e a s h T h e G l o w



---

**NEW GEN**

---

U n l e a s h T h e G l o w

**OWNER'S  
MANUAL**

**SCP-LS288S**

Bull Dot Enhanced Compact Red Expanded Laser

**SCP-LS289S**

Bull Dot Enhanced Compact Green Expanded Laser



# CAUTION!



If you need to mount the Laser onto a firearm, make sure firearm is not loaded before installation. Remove magazine and examine chamber. Use safe handling procedures at all times.

Always use safe handling procedures at all times. Do not operate the laser if the unit is defective or the cover or seal is damaged.

Avoid direct eye exposure to laser beam or bright reflection as this may cause eye injury.

Do not direct laser beam toward any aircraft, public transportation or other objects with safety concerns. This is very dangerous and may be considered a felony.

Do not direct laser beam toward any person or animal. Direct eye contact with beam or bright reflection may cause eye injury.

Ensure that the laser cannot be turned on when stored or being transported. If the lamp is activated while in a case or any container, the lamp could overheat and cause damage to surrounding materials.

Examine battery quality and appearance before use each time and make sure that there is no leaking or any deformation. Dispose appropriately if there is a problem.

The batteries are pre-charged by the manufacturer, and cannot be recharged. Recharging can cause battery leakage or, in some cases, high-pressure rupture. Inadvertent charging can occur if a battery is installed backwards.

Install batteries by aligning the + and - signs marked on the battery with the + and - signs marked on the battery chamber in the light.

Turn off the laser and remove batteries from laser after use. Leaving battery in without use for long period of time may cause damage or danger. Keep batteries cool and dry.

Do not use rechargeable battery in the system. Always replace battery with the exact type and size for the system.

Never deliberately short circuit battery. Prolonged short circuit will cause the battery to lose energy and result in significant temperature increase.

Do not carry the laser with batteries installed in the car trunk while driving during high temperature.

Keep battery compartment clean and keep any metallic object away from battery.

Lithium batteries can explode or cause burns if disassembled, shorted, recharged, exposed to water, fire, or high temperatures. Do not place loose batteries in a pocket, purse, or other container containing metal object. Do not mix new with used batteries or mix required batteries with other types of battery. Do not store batteries with hazardous or combustible materials. Store in cool, dry, ventilated area. Follow applicable laws and regulations for disposal.



**CAUTION:** Use of the product, its controls, adjustments, or performance of operations other than those specified herein may result in hazardous radiation exposure.

## Specification

	SCP-LS288S	SCP-LS289S
<b>Length</b>	2.8"	3.4"
<b>Width</b>	1.9"	1.9"
<b>Height</b>	1.4"	1.4"
<b>Weight (with Battery)</b>	4.9 oz	5.2 oz
<b>Structure &amp; Adjustment</b>	TS & 3 Points	TS & 3 Points
<b>Windage/Elevation Adjustment Range</b>	39"@100 yds	31"@100 yds
<b>Type</b>	CLASS 3R	CLASS 3R
<b>Output Power</b>	2 - 4.5mW	2 - 4.5mW
<b>Wavelength</b>	630 - 640nm	522 - 542nm
<b>Beam Diameter</b>	12" @100 yds (73°F ~ 81°F)	12" @100 yds (73°F ~ 81°F)
<b>Operating Temperature</b>	50°F ~ 100°F	50°F ~ 100°F
<b>Battery</b>	CR2 x 1	CR2 x 1
<b>Battery Operating Time</b>	6.5 hrs+	2.5 hrs+
<b>Laser Beam Life Time</b>	5000 hrs	5000 hrs

## Innovative and Robust TS Platform



Leapers/UTG has made tremendous breakthroughs in laser design by adopting the venerable TS Platform and Smart Spherical Structure. This guarantees that all lasers operate with the most responsive and precise windage and elevation adjustments, while providing unmatched reliability.

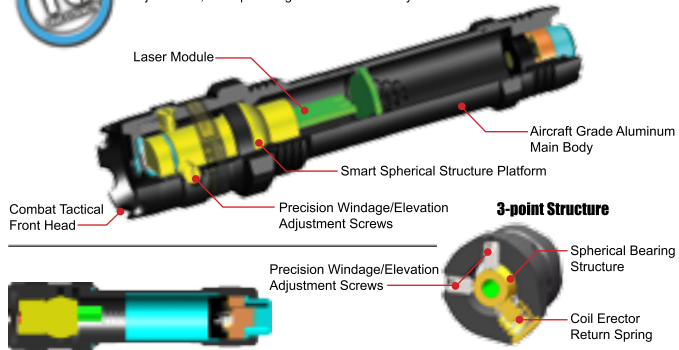

The purpose of the diagram is to provide a better understanding of the structure of the laser System. Please do NOT disassemble the product which will void its warranty.

## Component Illustration

SCP-LS288S

**RED LASER**



Textured Push Button Switch

Battery Compartment



Battery Compartment Cap

Windage/Elevation Adjustment Screws  
Windage/Elevation Adjustment Screws

SCP-LS288S  
(Model Number)  
QH4514UX32  
(Example Serial Number)

Built-in Integral Mount



## Component Illustration

SCP-LS289S

**GREEN LASER**



Textured Push Button Switch

Battery Compartment



Battery Compartment Cap

Windage/Elevation Adjustment Screws  
Windage/Elevation Adjustment Screws

SCP-LS289S  
(Model Number)  
QH4514UX32  
(Example Serial Number)

Built-in Integral Mount



## Parts



Base Locking Key



Windage/Elevation Adjustment  
Allen Wrench 2.5mm



Velcro Pad  
for Pressure Switch

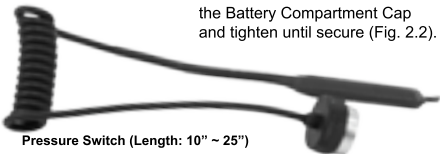

Pressure Switch (Length: 10" ~ 25")

## Installation & Operation

### Battery Installation

1. Unscrew the Battery Compartment Cap in the front by twisting it counter-clockwise (Fig. 1.1).
2. Insert one CR2 lithium battery into the compartment (Fig. 1.2).
3. Replace the Battery Compartment Cap and tighten it until secure (Fig. 1.3).

### Pressure Switch Installation

1. Unscrew the Battery Compartment Cap in the front by twisting it counter-clockwise (Fig. 2.1). Make sure to keep the cap in a safe place for replacement when Pressure Switch is not used.
2. Use the cap at one end of the Pressure Switch as the Battery Compartment Cap and tighten until secure (Fig. 2.2).



Fig. 1.1



Fig. 1.2



Fig. 1.3



Fig. 2.1



Fig. 2.2



Fig. 3

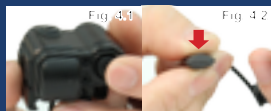

Fig. 4.1

Fig. 4.2



Fig. 5.1

Rifle Application Shotgun Application



Fig. 5.2



20 in-lb

Fig. 5.3

20 in-lb

## On/Off Operations

1. Direct Activation -  
Press and release the Push Button to turn on/off (Fig. 3).
2. Pressure Switch Activation -
  - a. Install the Pressure Switch (Fig. 2.1 - Fig. 2.2).
  - b. Press and release the Push Button to "activate" the Laser for Pressure Switch operation (Fig. 4.1).
  - c. Turn on/off the laser by depressing/releasing the press pad of the switch (Fig. 4.2).
  - d. When done using the Pressure Switch, always use the Push Button to shut off(deactivate) for safety and energy saving.

**Note: Pressure Switch will only work after the laser is "activated".**

## Mounting the Laser

1. Loosen the Cross-bolt Locking Knob (Fig. 5.1).
2. Slide the mounting base onto a rail (Fig. 5.2).
3. Tighten the Cross-bolt Locking Knob at the base with the included Base Locking Key to secure a positive lock on the rail (Fig. 5.3). Recommended torque value: 20 inch-lb.



**Do not over tighten the Cross-bolt Locking Knob as you could cause damage to the body.**

## Windage/Elevation Adjustment

SCP-LS288S / SCP-LS289S

RED LASER / GREEN LASER

**Elevation Adjustment:**

To move the laser beam upward/downward

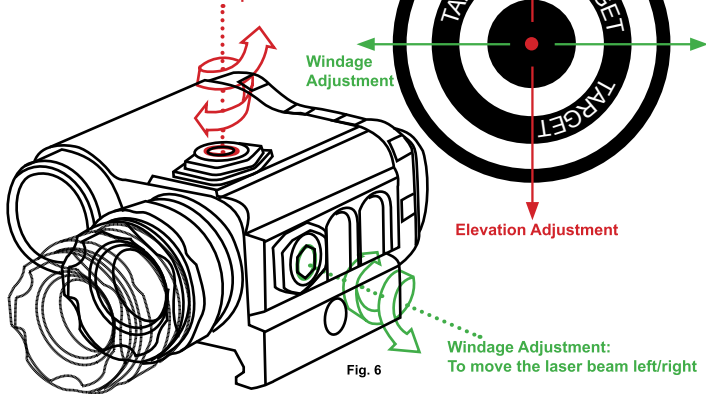















Fig. 6

**Windage Adjustment:**  
To move the laser beam left/right



1. Once the Laser is mounted in position, the Adjustment Screw on the bottom of the Laser becomes the Elevation Adjustment Screw, and the Adjustment Screw on the side of the Laser becomes the Windage Adjustment Screw.
2. Stabilize the firearm to minimize any unexpected movement. Fire a test shot. If the impact point of the bullet is exactly in the center of the target, then the Laser Sight is zeroed. Otherwise, it needs to be adjusted based on the bullet impact. To move the laser beam upward/downward, use Allen wrench to rotate the Elevation Adjustment Screw. To move the laser beam left/right, rotate the Windage Adjustment Screw.
3. Keep test firing and adjusting until achieving zero.

**NOTE:** To optimize the Windage/Elevation Adjustment function, the positions of the Windage/Elevation Adjustment Screws on each laser unit were pre-set on factory equipment. The Windage Adjustment Screw could be on either side of the unit, thus may appear different from the example illustration in Fig. 6. **PLEASE DO NOT ROTATE THE LASER HEAD.** To use the Windage/Elevation function, refer to the 'IMPACT POINT MOVEMENT INSTRUCTION' table and follow the Windage/Elevation adjustment instructions on Page 10.

IMPACT POINT MOVEMENT INSTRUCTION		Adjustment Screw Positions (From Rear of Laser)	
			
Windage/Elevation Adjustment		Bullet Impact Point Movement	
Windage			
			
Elevation			
			

## Replacement Parts

Contact your distributor for information:

	
BAT-LIT750	
1PC of CR2 Lithium Battery	Pressure Switch

## Maintenance

1. Maintain the metal surface of the Laser by removing any dirt or sand with a soft brush to avoid scratching the finish.
2. Store the system in a cool dry place when not in use. Be careful to avoid contact with acid, alkaline or corrosive chemicals.
3. Removed the batteries when not in use. This insures good working batteries for your system and prevents battery leakage.
4. Do not store your system in high temperatures. This would damage your laser sight and may result in battery leakage.
5. Do not put the laser head against any surface especially paper or human skin for it has heat and may result in accidents.
6. Do not leave your system under the seat in your car, or in direct sunlight to avoid over-heating.
7. Make sure that power is at off position before storing it away.
8. Do not attempt to lubricate any part of the system.
9. Do not disassemble the system other than replacing the pressure switch. Do not loosen or remove screws or parts. Any such or similar actions will void the warranty.
10. For laser products, service is only to be handled by authorized factory trained technicians. There is no product service or user serviceable parts allowed by the customer.

## One Year Limited Warranty

This warranty covers defects in materials and workmanship of the product, provided that they are purchased from an authorized distributor and purchased and used in the United States. The warranty lasts for a period of one year from the date of original purchase of the product.

You are entitled to rights under this warranty only if you are the original purchaser of the product and have the original purchase receipt. This warranty is not transferable. We will at our option, repair or replace products that do not conform to this warranty. We may use functionally equivalent reconditioned, refurbished, remanufactured, pre-owned or new products or parts.

This warranty is void if:

- the product has been disassembled, tampered with or parts or screws have been removed or loosened; or
- the product has been abused, maliciously damaged, mistreated or used for a purpose contrary to the purpose for which it was designed or the instructions provided with the product.

For Warranty service, please contact your authorized distributor and provide them with a written description of the defect and your original purchase receipt. You must obtain a Return Authorization Number and return procedures with delivery destination before returning the product for repair or replacement. For further warranty service information, contact: Customer Service Department, Leapers®, Inc., 32700 Capitol Street, Livonia, MI 48150; (734) 542-1500.

## Disclaimer and Limitation of Liability

Leapers is pleased to offer suggestions of the use of its products, however Leapers neither assumes responsibility for any omissions or errors nor assumes liability for any damages that result from the use of its products in accordance with information provided by Leapers, whether verbal or written.

EXCEPT FOR THE EXPRESS WRITTEN WARRANTY SPECIFICALLY SET FORTH ABOVE, ALL EXPRESS AND IMPLIED REPRESENTATIONS AND WARRANTIES ARE HEREBY DISCLAIMED, INCLUDING ANY IMPLIED WARRANTY OF MERCHANTABILITY, NON-INTERFERENCE, FITNESS FOR A PARTICULAR PURPOSE, NON-INFRINGEMENT, OR WARRANTY OF ACCURACY OF ANY INFORMATION PROVIDED WHETHER WRITTEN OR ORAL. ALL WARRANTIES ARISING FROM ANY COURSE OF DEALING, LAW, USAGE OR TRADE PRACTICE ARE HEREBY EXPRESSLY EXCLUDED TO THE EXTENT ALLOWED BY LAW. TO THE EXTENT AN IMPLIED WARRANTY CANNOT BE EXCLUDED, SUCH WARRANTY IS LIMITED IN DURATION TO ONE YEAR. SOME STATES OR JURISDICTIONS DO NOT ALLOW LIMITATIONS ON HOW LONG AN IMPLIED WARRANTY LASTS, SO THE ABOVE LIMITATION MAY NOT APPLY TO YOU.

UNDER NO CIRCUMSTANCES IS LEAPERS, OR ITS SUPPLIERS OR RESELLERS LIABLE FOR ANY OF THE FOLLOWING EVEN IF INFORMED OF THEIR POSSIBILITY: 1) THIRD PARTY CLAIMS AGAINST YOU FOR DAMAGES; 2) SPECIAL, INCIDENTAL, OR INDIRECT DAMAGES OR FOR ANY ECONOMIC CONSEQUENTIAL DAMAGES; OR 3) LOST PROFITS, BUSINESS REVENUE, GOODWILL, OR ANTICIPATED SAVINGS. SOME STATES OR JURISDICTIONS DO NOT ALLOW THE EXCLUSION OR LIMITATION OF INCIDENTAL OR CONSEQUENTIAL DAMAGES, SO THE ABOVE LIMITATION OR EXCLUSION MAY NOT APPLY TO YOU.